

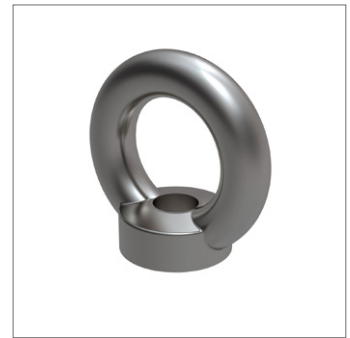

# Steel Female Lifting Eye Bolts

metric sizes

## Lifting Eye Bolts & Nuts

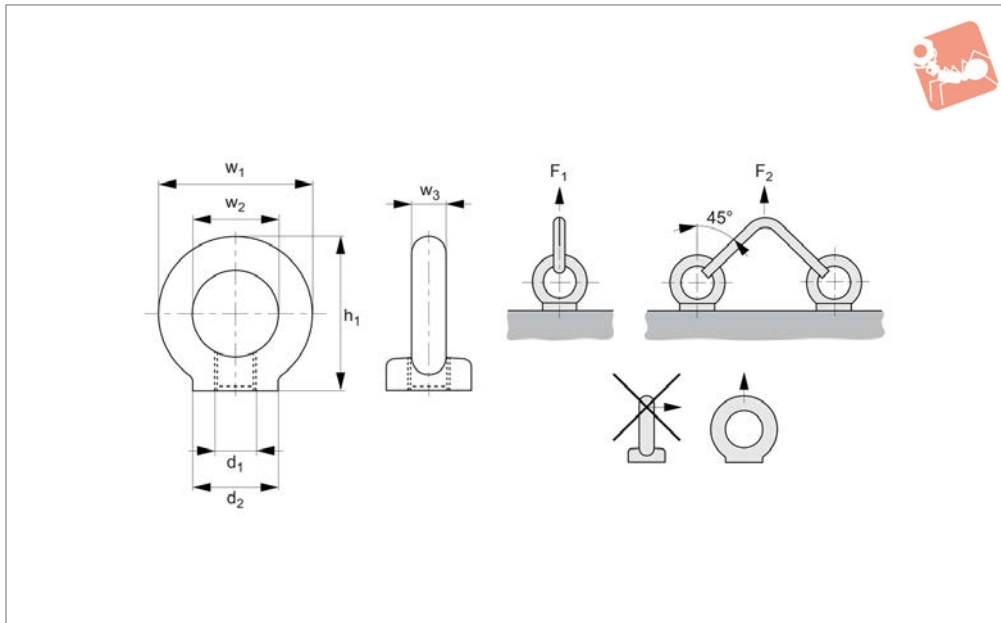

**18843**

LIFTING EYE BOLTS & NUTS

### Material

Forged steel (C15E) annealed and zinc plated. Contact face machined. CE marked.

Hot dipped galvanised versions (for more demanding applications and limited outside use) also available on request, suffix changes to -GV.

### Technical Notes

To DIN 582.

When using lifting eye bolts it is critical to ensure that the face is in firm contact with

the mating surface.

These lifting bolts are generally installed and remain on a piece of equipment for the purpose of transporting them. They are not for repeated lifting use - if this is required our swivelling lifting bolt range should be used.

### Tips

Maximum load values are only applicable when the thread and the material, it is being used in is as least as strong as the

that of the bolt.

Temperature range -20°C to +200°C.

$F_1$  and  $F_2$  values given are for steel and cast iron components.

### Important Notes

Not to be used at lift angles of greater than 45° or with swivelling loads.

**Please refer to the safety documentation before using this part.**

**Supplied with certificate and operating instructions.**

Order No.	Thread	d <sub>1</sub>	d <sub>2</sub>	w <sub>1</sub>	h <sub>1</sub>	w <sub>2</sub>	w <sub>3</sub>	F <sub>1</sub> kg max.	F <sub>2</sub> kg max.	Weight kg
18843.W0006	Coarse	M 6	20	36	36	20	8	70	50	0.05
18843.W0008	Coarse	M 8	20	36	36	20	8	140	95	0.05
18843.W0010	Coarse	M10	25	45	45	25	10	230	170	0.09
18843.W0012	Coarse	M12	30	54	53	30	12	340	240	0.16
18843.W0016	Coarse	M16	35	63	62	35	14	700	500	0.24
18843.W0020	Coarse	M20	40	72	71	40	16	1200	830	0.36
18843.W0024	Coarse	M24	50	90	90	50	20	1800	1270	0.72
18843.W0030	Coarse	M30	65	108	109	60	24	3200	2300	1.32
18843.W0036	Coarse	M36	75	126	128	70	28	5100	3700	2.08
18843.W0042	Coarse	M42	85	144	147	80	32	7000	4500	3.11
18843.W0048	Coarse	M48	100	166	168	90	38	8600	6100	5.02
18843.W0056	Coarse	M56	110	184	187	100	42	11500	8200	6.70
18843.W0064	Coarse	M64	120	206	208	110	48	16000	11000	9.30
18843.W0072	Coarse	M72x6	150	260	260	140	60	20000	14000	18.5
18843.W0080	Coarse	M80x6	170	296	298	160	68	28000	20000	27.3
18843.W0100	Coarse	M100x6	190	330	330	180	75	40000	29000	26.4
18843.W5016	Fine	M16 x 1,5	35	63	62	35	14	700	500	0.24
18843.W5020	Fine	M20 x 2,0	40	72	71	40	16	1200	830	0.36
18843.W5024	Fine	M24 x 2,0	50	90	90	50	20	1800	1270	0.72
18843.W5030	Fine	M30 x 2,0	65	108	109	60	24	3600	2600	1.32
18843.W5036	Fine	M36 x 3,0	75	126	128	70	28	5100	3700	2.08
18843.W5042	Fine	M42 x 3,0	85	144	147	80	32	7000	5000	3.11
18843.W5048	Fine	M48 x 3,0	100	166	168	90	38	8600	6100	5.02



Order No.	Thread	$d_1$	$d_2$	$w_1$	$h_1$	$w_2$	$w_3$	$F_1$ kg max.	$F_2$ kg max.	Weight kg
<b>18843.W5056</b>	Fine	M56 x 4,0	110	184	187	100	42	11500	8300	6.69



# Introduction

## Swivel Lifting Rings and Lifting Bolts

# Lifting Bolts



		
<b>Single swivel</b>	<b>Double swivel</b>	<b>Triple swivel</b>
Threads M8 – M48 Loads 0,3 tons to 15 tons	Threads M4 – M100 Loads 0,05 tons to 50 tons	Threads M8 – M56 Loads 0,3 tons to 22 tons

### Introduction to swivel lifting rings and Lifting Bolts (P4002-P4055)

Our swivel lifting rings fully comply with the EC directive 2006/42/EC. They are CE marked and are supplied with a Certificate of Conformity. There is a 100% check on anti-cracking, a proof load test of 2.5 x load limit and a safety factor of 5 on most parts. Each ring is individually marked to ensure full product traceability.

The Swivel Lifting Rings come in three main forms – depending on the number of axis required to swivel. The most popular type is the double swivel rings.

### Other Standard Lifting Bolts

#### Standard lifting bolts (to DIN 580 and DIN 582) (P4040-P4048)

These are CE marked and are available with male or female threads in either steel or stainless steel (A4 AISI 316). They are meant only for linear loading of the bolts at a maximum angle of 45° from the thread. They are not meant for loads that might swivel.

These are supplied with a generic CE Certificate of Conformity stating that the parts have been manufactured to the relevant DIN standard and therefore suitable for lifting.

#### High-tensile lifting bolts (P4054-P4055)

The High-tensile lifting bolts are similar to the standard lifting bolts but are rated at higher loads and can lift loads at up to 90° from the thread. They are not meant for loads that might swivel.

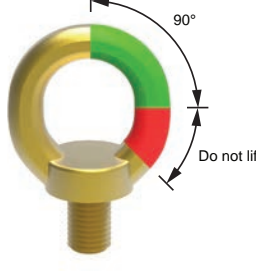
	
<b>Standard lifting bolts</b> DIN 580 & DIN 582 P4040-P4048	<b>Hi-tensile lifting bolts</b> P4054-P4055

### Swivel lifting rings operating instructions.

Please follow these instructions carefully.

- Ensure all lifting bolts are CE marked.
- Ensure they are handled by qualified personnel.
- Refer to the operating instructions particularly with regards to product selection, any possibility of the load swivelling, the effect of lifting angles on the load capacity (see relevant tables), etc.
- Never allow any personnel underneath a suspended load.
- Always heed the load rating of the lifting bolt.
- Always perform a visual inspection of the lifting rings prior to use. Checking for any damage to thread and/or swivelling system. Check for wear or corrosion, signs of stress or bending. Check CE mark and load rating.
- Ensure a yearly full service inspection is performed.
- Always ensure the full bottom face of the lifting bolts is in contact with a smooth, square surface.
- Ensure bolt is tightened to the correct torque.
- Ensure full and unrestricted movement of the lifting ring in all directions.
- Before each lift ensure the correct orientation of the shackle in the lift direction.
- Avoid using our standard steel lifting rings in corrosive environments eg sandy, chemical, acid, moisture etc. In this case consider using our stainless steel lifting rings.

- Note the thread length requirements:
  - 1 x thread diameter for steel (ST37 min.).
  - 1.25 x thread diameter for cast iron.
  - 2 x thread diameter for aluminium.
  - 2.5 x thread diameter for other light metals.
  - If fixing into low resistance material it is better to allow for a bigger diameter thread to compensate for the lower material resistance.

Note: The full thread must be engaged. Longer thread lengths can be supplied on request or a bolt and washer/nut combination can be used.





### Temperature extremes

- 40°C to -20°C Load rating reduces by 20%.
- +200°C to +300°C Load rating reduces by 10%.
- +300°C to +400°C Load rating reduces by 25%.

### Rugged

For harsh environments we recommend the use of our stainless steel lifting rings.

### Product marking

Compliant with 2006/42/EC, and with individual date of manufacture and batch number.

Complies with 2006/42/CE



### Lifting angles

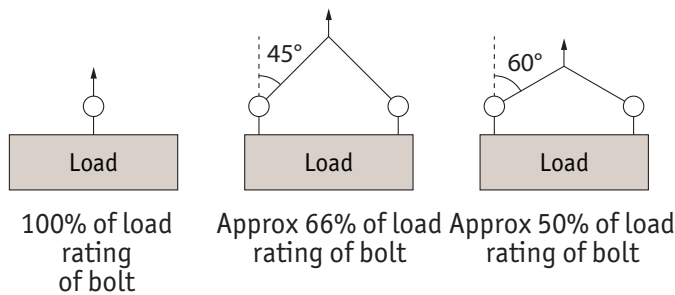

For full information on lifting arrangements see technical pages

### Steel and Stainless steel (316) versions



Steel



Stainless (316L)

### P4020

Threads M8 – M30  
Loads 0,3 tons to 3 tons.



### P4022

Threads M30 – M45  
Loads 3,5 tons to 6 tons.



### Installation Information

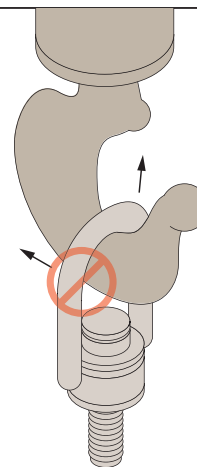

**Never** use an oversized hook or other lifting device which will pry or tend to open the "U" shaped bar on center pull hoist rings.

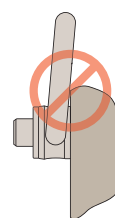

After installation, check the hoist ring to be sure it swivels and pivots freely in all directions. **The side of the ring must not contact anything.**

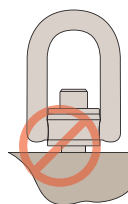

**Always** ensure full thread engagement when installing hoist rings. Also ensure face is flush.

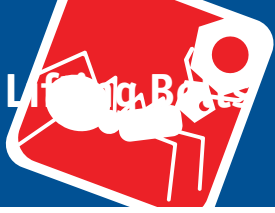

# Technical Information

## Single Swivel Lifting Rings

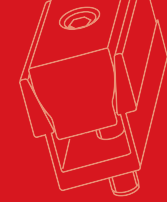

P4002 Male



P4004 Female



Lifting type	0°		90°		α max. = 60°		α max. = 60°			
	1	2	1	2	2	2	4	4		
No. of rings	1	2	1	2	2	2	4	4		
Lifting angle	0°	0°	90°	90°	45°	60°	45°	60°		
Part no.	Thread									
P4002.M008 & P4004.M008	M 8		0,30 tons	0,60 tons	0,30 tons	0,60 tons	0,40 tons	0,30 tons	0,60 tons	0,30 tons
P4002.M010 & P4004.M010	M10		0,60 tons	1,20 tons	0,60 tons	1,20 tons	0,80 tons	0,60 tons	1,30 tons	0,60 tons
P4002.M012 & P4004.M012	M12		1,00 tons	2,00 tons	1,00 tons	2,00 tons	1,40 tons	1,00 tons	2,10 tons	1,00 tons
P4002.M016 & P4004.M016	M16		1,60 tons	3,20 tons	1,60 tons	3,20 tons	2,20 tons	1,60 tons	3,40 tons	1,60 tons
P4002.M020 & P4004.M020	M20		2,50 tons	5,00 tons	2,50 tons	5,00 tons	3,50 tons	2,50 tons	5,30 tons	2,50 tons
P4002.M024 & P4004.M024	M24		4,00 tons	8,00 tons	4,00 tons	8,00 tons	5,60 tons	4,00 tons	8,40 tons	4,00 tons
P4002.M030 & P4004.M030	M30		6,30 tons	12,60 tons	6,30 tons	12,60 tons	8,80 tons	6,30 tons	13,20 tons	6,30 tons
P4002.M036 & P4004.M036	M36		10,00 tons	20,00 tons	10,00 tons	20,00 tons	14,00 tons	10,00 tons	21,00 tons	10,00 tons
P4002.M042	M42		12,50 tons	25,00 tons	12,50 tons	25,00 tons	17,50 tons	12,50 tons	26,30 tons	12,50 tons
P4002.M048	M48		15,00 tons	30,00 tons	15,00 tons	30,00 tons	21,00 tons	15,00 tons	31,50 tons	15,00 tons



P4005 Male



P4006 Female



Lifting type									$\alpha$ max. = 60° 		$\alpha$ max. = 60° 	
	1	2	1	2	2	2	4	4				
No. of rings	1	2	1	2	2	2	4	4				
Lifting angle	0°	0°	90°	90°	45°	60°	45°	60°				
Part no.	Thread											
P4005.M004	M 4	0,050 tons	0,100 tons	0,050 tons	0,100 tons	0,070 tons	0,050 tons	0,100 tons	0,050 tons			
P4005.M005	M 5	0,075 tons	0,150 tons	0,075 tons	0,150 tons	0,100 tons	0,075 tons	0,150 tons	0,075 tons			
P4005.M006	M 6	0,100 tons	0,200 tons	0,100 tons	0,200 tons	0,140 tons	0,100 tons	0,200 tons	0,100 tons			
P4005.M008 & P4006.M008	M 8	0,30 tons	0,60 tons	0,30 tons	0,60 tons	0,40 tons	0,30 tons	0,60 tons	0,30 tons			
P4005.M010 & P4006.M010	M10	0,60 tons	1,20 tons	0,60 tons	1,20 tons	0,80 tons	0,60 tons	1,30 tons	0,60 tons			
P4005.M012 & P4006.M012	M12	1,00 tons	2,00 tons	1,00 tons	2,00 tons	1,40 tons	1,00 tons	2,10 tons	1,00 tons			
P4005.M014 & P4006.M014	M14	1,30 tons	2,60 tons	1,30 tons	2,60 tons	1,80 tons	1,30 tons	2,70 tons	1,30 tons			
P4005.M016 & P4006.M016	M16	1,60 tons	3,20 tons	1,60 tons	3,20 tons	2,20 tons	1,60 tons	3,40 tons	1,60 tons			
P4005.M018 & P4006.M018	M18	2,00 tons	4,00 tons	2,00 tons	4,00 tons	2,80 tons	2,00 tons	4,20 tons	2,00 tons			
P4005.M020 & P4006.M020	M20	2,50 tons	5,00 tons	2,50 tons	5,00 tons	3,50 tons	2,50 tons	5,30 tons	2,50 tons			
P4005.M022 & P4006.M022	M22	3,00 tons	6,00 tons	3,00 tons	6,00 tons	4,20 tons	3,00 tons	6,30 tons	3,00 tons			
P4005.M024	M24	4,00 tons	8,00 tons	4,00 tons	8,00 tons	5,60 tons	4,00 tons	8,40 tons	4,00 tons			
P4005.M027	M27	5,00 tons	10,00 tons	5,00 tons	10,00 tons	7,00 tons	5,00 tons	10,50 tons	5,00 tons			
P4005.M030	M30	6,30 tons	12,60 tons	6,30 tons	12,60 tons	8,8 tons	6,30 tons	13,20 tons	6,30 tons			
P4005.I031 & P4006.I031	(UNC 5/16"-18)	650 lbs	1,300 lbs	650 lbs	1,300 lbs	910 lbs	650 lbs	1,365 lbs	650 lbs			
P4005.I037 & P4006.I037	(UNC 3/8"-16)	1,200 lbs	2,400 lbs	1,200 lbs	2,400 lbs	1,680 lbs	1,200 lbs	2,520 lbs	1,200 lbs			
P4005.I050 & P4006.I050	(UNC 1/2"-13)	2,200 lbs	4,400 lbs	2,200 lbs	4,400 lbs	3,080 lbs	2,200 lbs	4,620 lbs	2,200 lbs			
P4005.I063 & P4006.I063	(UNC 5/8"-11)	3,800 lbs	7,600 lbs	3,800 lbs	7,600 lbs	5,320 lbs	3,800 lbs	7,980 lbs	3,800 lbs			
P4005.I075 & P4006.I075	(UNC 3/4"-10)	5,500 lbs	11,000 lbs	5,500 lbs	11,000 lbs	7,700 lbs	5,500 lbs	11,550 lbs	5,500 lbs			
P4005.I088 & P4006.I088	(UNC 7/8"-9)	6,600 lbs	13,200 lbs	6,600 lbs	13,200 lbs	9,240 lbs	6,600 lbs	13,860 lbs	6,600 lbs			
P4005.I100	(UNC 1"-8)	10,000 lbs	20,000 lbs	10,000 lbs	20,000 lbs	14,000 lbs	10,000 lbs	21,000 lbs	10,000 lbs			