

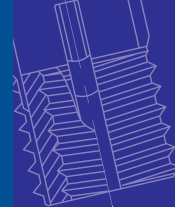

Extension Nuts

strength class 10



Nuts

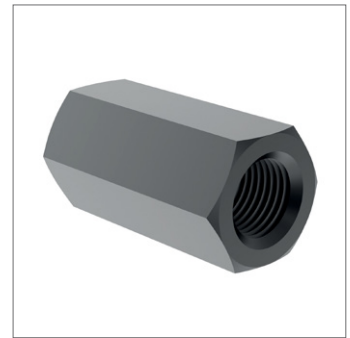
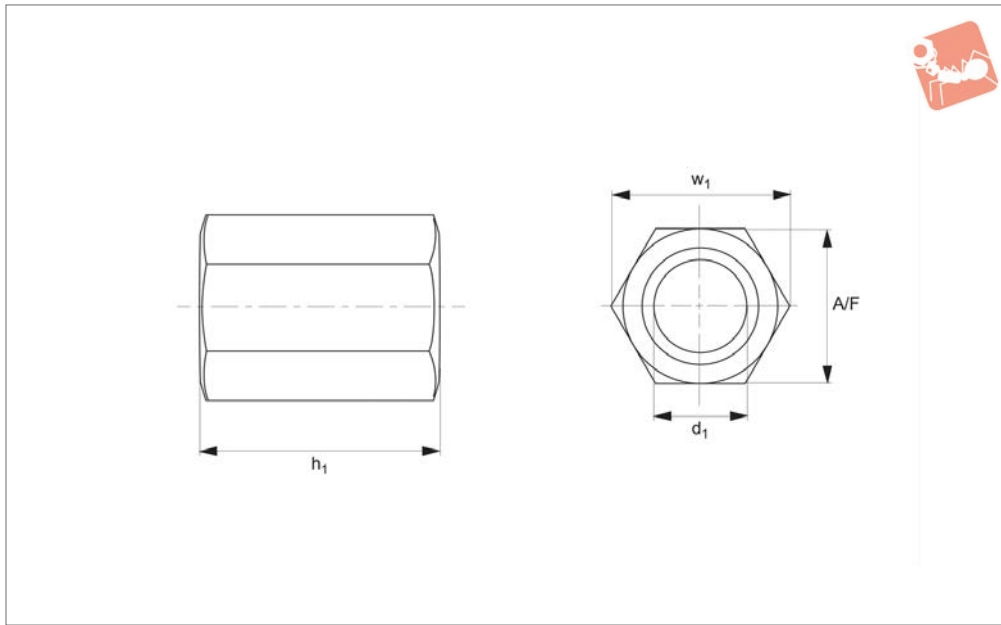

24600

NUTS

Material

Steel heat-treated.
Tensile strength class 10.

Technical Notes

Produced to DIN 6334.

Used for joining T-bolts and studs together. For safety the T-bolts/studs should be screwed half the length of the coupling nut either side. Minimum screwed in thread length should be 1 x diameter.

Order No.	d_1	w_1	$h_1 = 3 \times d_1$	A/F	Weight g
24600.W0106	M 6	11.1	18	10	8
24600.W0108	M 8	14.4	24	13	19
24600.W0110	M10	17.8	30	16	30
24600.W0112	M12	20.0	36	18	48
24600.W0114	M14	23.4	42	21	73
24600.W0116	M16	26.8	48	24	120
24600.W0118	M18	30.1	54	27	170
24600.W0120	M20	33.5	60	30	240
24600.W0122	M22	37.7	66	34	390
24600.W0124	M24	40.0	72	36	400
24600.W0127	M27	45.6	81	41	600
24600.W0130	M30	51.3	90	46	850
24600.W0136	M36	61.3	108	55	1470
24600.W0142	M42	72.6	126	65	2340
24600.W0148	M48	83.9	144	75	3600



Nuts

Available in heat treated steel, unless stated otherwise.

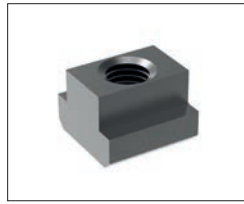

24000 T-Nut, Strength Class 10 DIN 508.

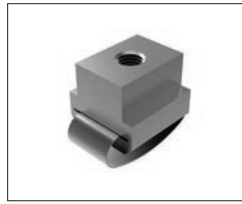

24010 T-Nut with Anti-Slip Device.

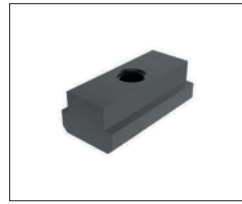

24100 Extended T-Nut. Strength Class 10.

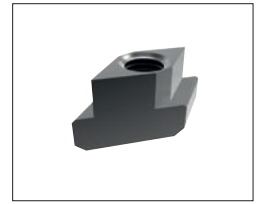

24120 Rhombus T-Nuts

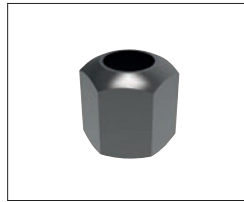

24300 Fixture Nuts. Strength Class 10 - DIN 6330B

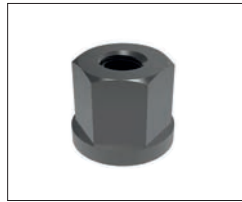

24400 Collar Nuts, DIN 6331

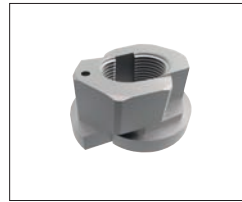

24502 Fast Nut - With Collar Rapid Assembly Nut

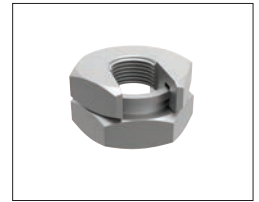

24520 - Steel Slip-On Lock Nuts - Rapid Assembly Nut.



24600 Extension Nuts Strength Class 10.



24620 Swivel Nuts, Conical Seat

Washers

Available in a range of steel types - see product for details.



25000 - Hardened Steel - Plain Washers. DIN 6340.



25100 - Case Hardened Steel - Spherical Seat Washers. Type C - DIN 6319C.



25400 - Case Hardened Steel - Dished Washers, Type D - DIN 6319D.



25700 - Tempered Steel - Dished Washers, Type G - DIN 6319G.



25900 - Stainless Steel Compact Spherical Washer, Conical Seat, similar to DIN6319