

63050

LIFTING POINTS & SHACKLES

Material

High tensile steel, strength class >8.
Supplied with CE certificate.

Technical Notes

Double articulation.
Very low overhang for improved safety.
Large support surface.
Longer or shorter thread lengths can be supplied but please consult our technical department for this information if required.
For use in temperatures from -20°C to +200°C. Can be used in lower or higher

temperatures but this affects the load rating – please ask for more information. Please refer to our technical information pages when specifying and/or using.

Tips

Double articulation allows perfect alignment with the sling if the part rotates during the lift.
With „automatic“ position recovery system for best orientation to sling direction.
Tighten by hex. key or spanner.

Important Notes

The thread diameter and depth must be appropriate to the material into which it will be installed:
Steel (min. ST37) – 1 x thread dia.
Cast iron – 1.25 x thread dia.
Aluminium – 2 x thread dia.
Other light metals – 2.5 x thread dia.
Tolerance of female thread to be 6H (metric) or UNC-2B (inch).
Please refer to the safety documentation before using this part.
Supplied with certificate and operating

| Order No. | Load tons (t) max. | d ₁ tol. 6g (tol. 2A) | l ₁ | h ₁ | h ₂ | h ₃ | h ₄ | h ₅ | w ₁ | d ₂ | w ₂ | A/F ₁ | A/F ₂ | Safety factor | Torque to Nm (ft·lb) | Weight kg |
|-------------|--------------------|----------------------------------|----------------|----------------|----------------|----------------|----------------|----------------|----------------|----------------|----------------|------------------|------------------|---------------|----------------------|-----------|
| 63050.W0005 | 0,1 | M 5x 0,80 | 15 | 33 | 9,5 | 30 | 38 | 14 | 53 | 30 | 27 | 8 | 16 | 4 | 3 | 0,3 |
| 63050.W0006 | 0,2 | M 6x 1,00 | 15 | 33 | 9,5 | 30 | 38 | 14 | 53 | 30 | 27 | 8 | 16 | 4 | 4 | 0,3 |
| 63050.W0008 | 0,5 | M 8x 1,25 | 15 | 33 | 9,5 | 30 | 38 | 14 | 53 | 30 | 27 | 8 | 16 | 4 | 6 | 0,3 |
| 63050.W0010 | 0,9 | M10x1,50 | 18 | 33 | 9,5 | 30 | 38 | 14 | 53 | 30 | 27 | 8 | 16 | 4 | 10 | 0,3 |
| 63050.W0012 | 1,3 | M12x1,75 | 21 | 33 | 9,5 | 30 | 38 | 14 | 53 | 30 | 27 | 8 | 16 | 4 | 15 | 0,3 |
| 63050.W0014 | 1,8 | M14x2,00 | 23 | 45 | 13 | 40 | 53 | 17 | 76 | 45 | 38 | 8 | 20 | 4 | 30 | 0,9 |
| 63050.W0016 | 2,3 | M16x2,00 | 27 | 45 | 13 | 40 | 53 | 17 | 76 | 45 | 38 | 8 | 20 | 4 | 50 | 0,9 |
| 63050.W0018 | 2,3 | M18x2,50 | 27 | 45 | 13 | 40 | 53 | 17 | 76 | 45 | 38 | 8 | 20 | 4 | 70 | 0,9 |
| 63050.W0020 | 2,5 | M20x2,50 | 30 | 45 | 13 | 40 | 53 | 17 | 76 | 45 | 38 | 8 | 20 | 4 | 100 | 0,9 |
| 63050.W0022 | 4,5 | M22x2,50 | 33 | 62 | 19 | 55 | 83 | 25 | 115 | 60 | 55 | 14 | 24 | 4 | 120 | 2,6 |
| 63050.W0024 | 5,5 | M24x3,00 | 36 | 62 | 19 | 55 | 83 | 25 | 115 | 60 | 55 | 14 | 24 | 4 | 160 | 2,6 |
| 63050.W0027 | 6,0 | M27x3,00 | 40 | 62 | 19 | 55 | 83 | 25 | 115 | 60 | 55 | 14 | 24 | 4 | 200 | 2,7 |
| 63050.W0030 | 6,3 | M30x3,50 | 45 | 62 | 19 | 55 | 83 | 25 | 115 | 60 | 55 | 14 | 24 | 4 | 250 | 2,7 |
| 63050.W0031 | (1,200) | (UNC 5/16"-18) | 15 | 33 | 9,5 | 30 | 38 | 14 | 53 | 30 | 27 | 8 | 16 | 4 | (5) | 0,3 |
| 63050.W0038 | (1,600) | (UNC 3/8"-16) | 17 | 33 | 9,5 | 30 | 38 | 14 | 53 | 30 | 27 | 8 | 16 | 4 | (8) | 0,3 |
| 63050.W0050 | (2,800) | (UNC 1/2"-13) | 21 | 33 | 9,5 | 30 | 38 | 14 | 53 | 30 | 27 | 8 | 16 | 4 | (12) | 0,3 |
| 63050.W0058 | (4,900) | (UNC 5/8"-11) | 27 | 45 | 13 | 40 | 53 | 17 | 76 | 45 | 38 | 8 | 20 | 4 | (40) | 0,9 |
| 63050.W0075 | (5,250) | (UNC 3/4"-10) | 30 | 45 | 13 | 40 | 53 | 17 | 76 | 45 | 38 | 8 | 20 | 4 | (80) | 0,9 |
| 63050.W0100 | (12,500) | (UNC 1"-8) | 36 | 62 | 19 | 55 | 83 | 25 | 115 | 60 | 55 | 14 | 24 | 4 | (125) | 2,6 |



General product information

Lifting angles

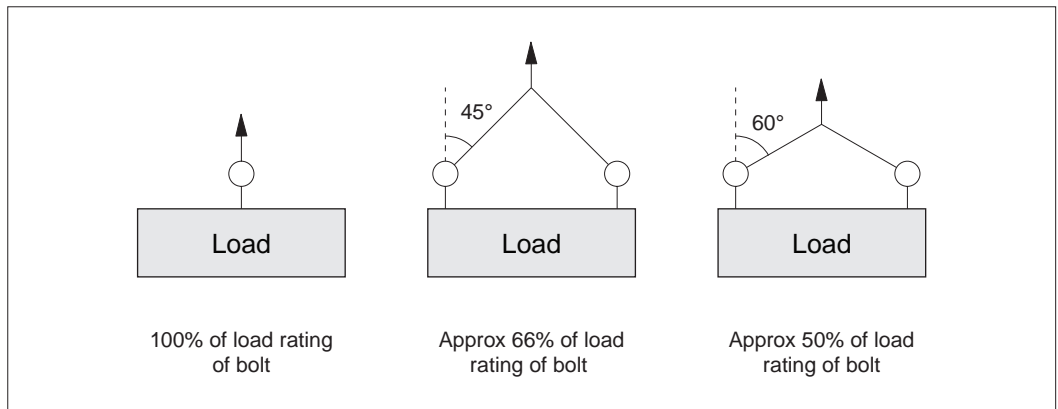

For full information on lifting arrangements see technical pages

Installation information

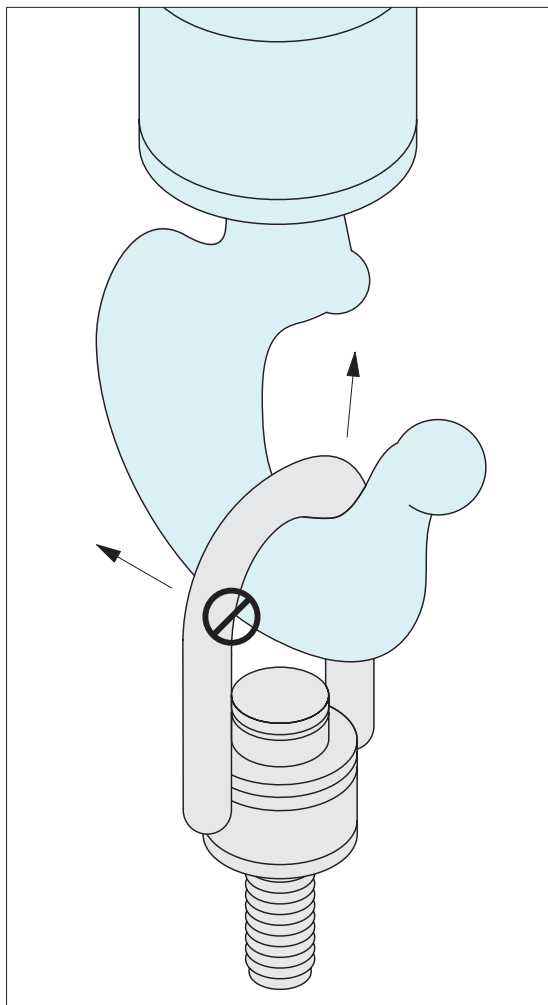

Never use an oversized hook or other lifting device which will pry or tend to open the "U" shaped bar on centre pull hoist rings.

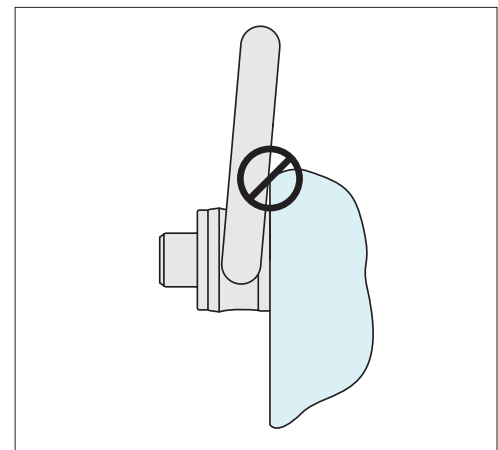

After installation, check the hoist ring to be sure it swivels and pivots freely in all directions. The side of the ring must not contact anything.

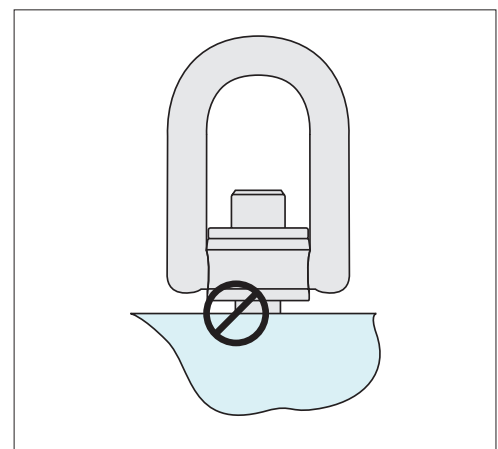

Always ensure full thread engagement when installing hoist rings.



Instructional Overview

- Ensure all lifting bolts are CE marked.
- Ensure they are handled by qualified personnel.
- Refer to the operating instructions particularly with regards to product selection, any possibility of the load swivelling, the effect of lifting angles on the load capacity (see relevant tables), etc.
- Never allow any personnel underneath a suspended load.
- Always heed the load rating of the lifting bolt.
- Always perform a visual inspection of the lifting rings prior to use. Checking for any damage to thread and/or swivelling system. Check for wear or corrosion, signs of stress or bending.
- Ensure a yearly full service inspection is performed.
- Always ensure the full bottom face of the lifting bolts is in contact with a smooth, square surface.
- Ensure bolt is tightened to the correct torque.
- Ensure full and unrestricted movement of the lifting ring in all directions.
- Before each lift ensure the correct orientation of the shackle in the lift direction.
- Avoid using our standard steel lifting rings in corrosive environments eg. sandy, chemical, acid, moisture etc. In this case consider using our stainless steel lifting rings.
- Note the thread length requirements:
 - 1 x thread diameter for steel (ST37 min.).
 - 1.25 x thread diameter for cast iron.
 - 2 x thread diameter for aluminium.
 - 2.5 x thread diameter for other light metals.
 - If fixing into low resistance material it is better to allow for a bigger diameter thread to compensate for the lower material resistance.

Operating instructions

Note: The full thread must be engaged. Longer thread lengths can be supplied on request or a bolt and washer/nut combination can be used.

- 40°C to -20°C Load rating reduces by 20%.
- +200°C to +300°C Load rating reduces by 10%.
- +300°C to +400°C Load rating reduces by 25%.

Temperature extremes



For harsh environments we recommend the use of our stainless steel lifting rings.

Rugged environments



63210 - Threads M30 - M45
Loads 3,5 tons - 6 tons.

63200 - Threads M8 - M30
Loads 0,3 tons - 3 tons.

Certificate of Conformity



Swivel lifting rings

Our swivel lifting rings fully comply with the EC directive 2006/42/EC. They are CE marked and are supplied with a Certificate of Conformity. There is a 100% check on anti-cracking, a proof load test of 2.5 x load limit and a safety factor of 5 on most parts. Each ring is individually marked to ensure full product traceability.

The Swivel Lifting Rings come in three main forms – depending on the number of axis required to swivel. The most popular type is the double swivel rings.



Single swivel - threads M8 – M48
loads 0,3 tons – 15 tons

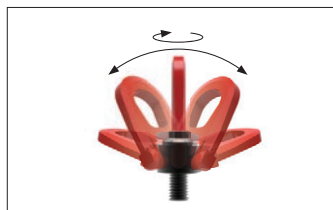

Double swivel - threads M4 – M100
loads 0,05 tons – 50 tons

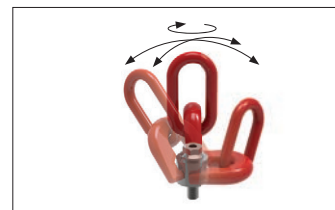

Triple swivel - threads M8 – M56
loads 0,3 tons – 22 tons

| Pros | Cons |
|--|------|
| ✓ Individual CE certification | |
| ✓ CE marked | |
| ✓ 100% physical check | |
| ✓ Proof load test of 2.5 x load limit | |
| ✓ Safety factor 5x stated load | |
| ✓ 100% traceability with individual marking | |
| ✓ Complies with 2006/42/CE | |
| ✓ Axial load | |
| ✓ Max. load bearing 90° | |
| ✓ Max. lateral load 90° | |
| ✓ Swivel loads | |
| ✓ Forces across lifting ring plane (double and triple swivel type) | |

High tensile lifting rings

The High-tensile lifting bolts are similar to the standard lifting bolts but are rated at higher loads and can lift loads at up to 90° from the thread. They are not meant for loads that might swivel.

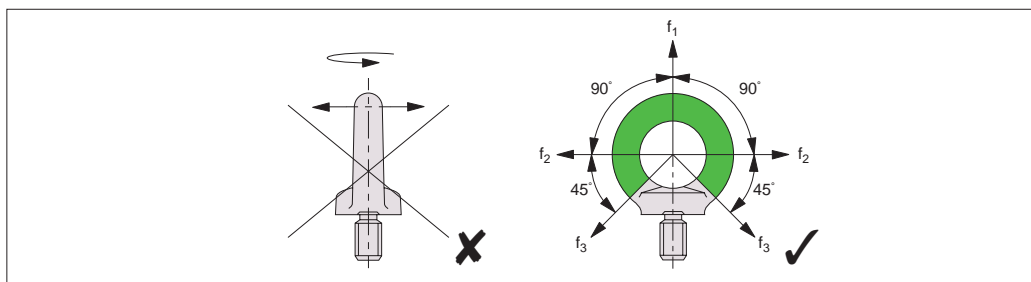

Important Note:
Forces must act in the direction of the lifting ring plane.

| Pros | Cons |
|-------------------------|------------------------------------|
| ✓ CE marked | ✗ Individual CE certification |
| ✓ Axial load | ✗ Shear tension |
| ✓ Max. load bearing 90° | ✗ Swivel loads |
| ✓ Max. lateral load 90° | ✗ Forces across lifting ring plane |

Standard lifting rings DIN580 and DIN582

These are CE marked and are available with male or female threads in either steel or stainless steel (A4 AISI 316). They are meant only for axial loads, or load bearing or lateral loads at a maximum of 45° from the thread. They are not for use under shear tension or loads (across the thread), nor for loads likely to swivel.

Applied forces must act in the direction of the eye bolt plane, do not apply forces across the eye bolt plane.

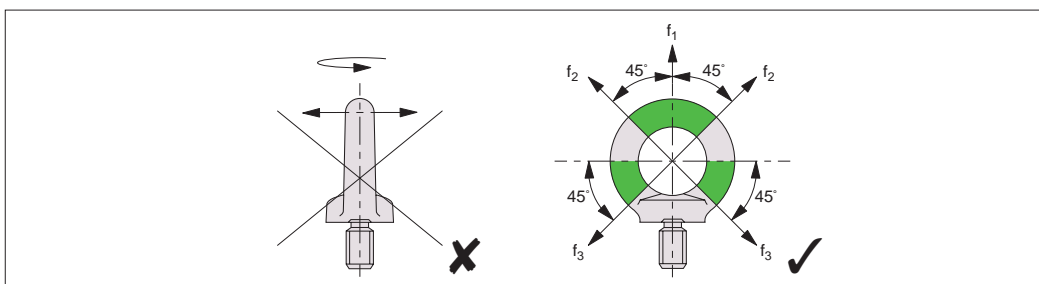

| Pros | Cons |
|-------------------------|------------------------------------|
| ✓ CE marked | ✗ Individual CE certification |
| ✓ Axial load | ✗ Shear tension |
| ✓ Max. load bearing 45° | ✗ Swivel loads |
| ✓ Max. lateral load 45° | ✗ Forces across lifting ring plane |

Important Note: Forces must act in the direction of the lifting ring plane.



Single Swivel Lifting Rings

max. load rating - per lifting configuration



63020 Male

| Lifting configuration | | | | | | | | | |
|-----------------------|---|-------|-------|-------|-------|-------|-------|-------|-------|
| No. of rings | 1 | 2 | 1 | 2 | 2 | 2 | 4 | 4 | 4 |
| Lifting angle | 0° | 0° | 90° | 90° | 45° | 60° | 45° | 60° | 60° |
| Thread | Maximum load rating for given lifting configuration | | | | | | | | |
| M8 tons | 0,30 | 0,60 | 0,30 | 0,60 | 0,40 | 0,30 | 0,60 | 0,30 | 0,60 |
| M10 tons | 0,60 | 1,20 | 0,60 | 1,20 | 0,80 | 0,60 | 1,30 | 0,60 | 1,20 |
| M12 tons | 1,00 | 2,00 | 1,00 | 2,00 | 1,40 | 1,00 | 2,10 | 1,00 | 1,40 |
| M16 tons | 1,60 | 3,20 | 1,60 | 3,20 | 2,20 | 1,60 | 3,40 | 1,60 | 2,40 |
| M20 tons | 2,50 | 5,00 | 2,50 | 5,00 | 3,50 | 2,50 | 5,30 | 2,50 | 3,50 |
| M24 tons | 4,00 | 8,00 | 4,00 | 8,00 | 5,60 | 4,00 | 8,40 | 4,00 | 5,60 |
| M30 tons | 6,30 | 12,60 | 6,30 | 12,60 | 8,80 | 6,30 | 13,20 | 6,30 | 8,80 |
| M36 tons | 10,00 | 20,00 | 10,00 | 20,00 | 14,00 | 10,00 | 21,00 | 10,00 | 14,00 |
| M42 tons | 12,50 | 25,00 | 12,50 | 25,00 | 17,50 | 12,50 | 26,30 | 12,50 | 17,50 |
| M48 tons | 15,00 | 30,00 | 15,00 | 30,00 | 21,00 | 15,00 | 31,50 | 15,00 | 21,00 |

Important Note: Table shows the maximum load rating for a given lifting configuration (NOT maximum load rating per individual lifting ring).