



Surface Mount - Leaf Hinges

screw mount - zinc



Hinges

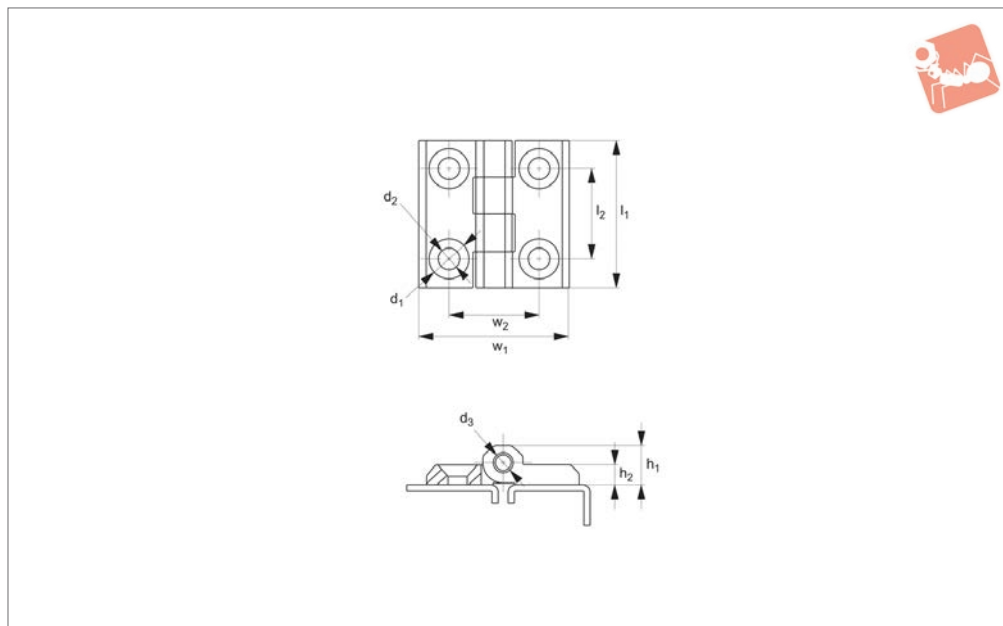

S0561

HINGES

Material

Black Coated

Body: die cast zinc, black powder coated.
Pin: steel, nickel plated.

Chrome

Body: die cast zinc, chrome plated.
Pin: steel, nickel plated.

Technical Notes

For plain/flush mounted doors, as well as electrical panels and covers. Opening angle 180°.

Order No.	Finish	Size	h_1	h_2	l_1	l_2	w_1	w_2	d_1	d_2	90° Angled stress kN	Axial load F_x N max.	Axial stress kN	Radial load F_x N max.	Radial stress kN
S0561.AW0040	Black Coated	40 x 40	9,0	5,0	40	25	40	25	10,2	5,3	2,00	1,2	1,45	1,0	2,1
S0561.AW0050	Black Coated	50 x 50	11,5	6,0	50	30	50	30	12,5	6,3	2,45	1,3	2,10	1,2	3,5
S0561.AW0060	Black Coated	60 x 60	15,0	8,0	60	36	60	36	16,5	8,4	4,40	1,8	3,20	1,5	6,0
S0561.AW0057	Black Coated	50 x 76	11,5	6,0	50	30	76	56	12,5	6,3	1,25	1,2	1,30	1,1	3,0
S0561.AW0612	Black Coated	60x120	15,0	8,0	60	36	120	88	12,5	6,8	1,50	1,2	1,30	1,1	4,5
S0561.AW0140	Chrome	40 x 40	9,8	5,2	40	25	40	25	5,2	2,00			1,45		2,1
S0561.AW0157	Chrome	50 x 76	11,0	6,0	50	30	76	55	6,3	2,45			2,10		3,5
S0561.AW0160	Chrome	60 x 60	17,2	8,2	60	38	60	36	8,2	1,25			1,30		3,0
S0561.AW0150	Chrome	50 x 50	11,2	6,0	50	30	50	30	6,3	4,40			3,20		6,0
S0561.AW1612	Chrome	60x120	17,2	8,2	60	90	120	36	8,2	1,50			1,30		4,5



Concealed hinges

For added security or a sleek enclosure design, concealed hinges offer the solution with mounting discreetly hidden away from view to avoid tampering.

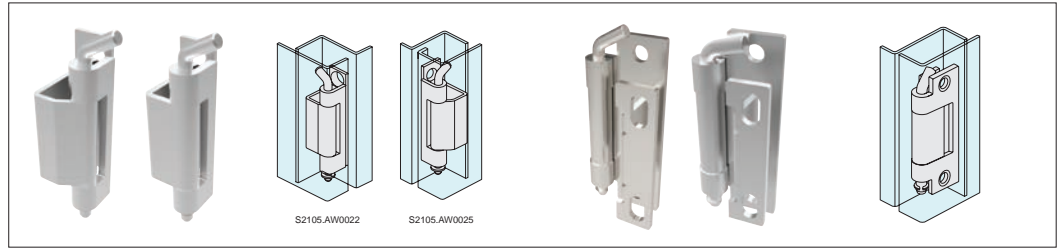

Concealed pivot hinges

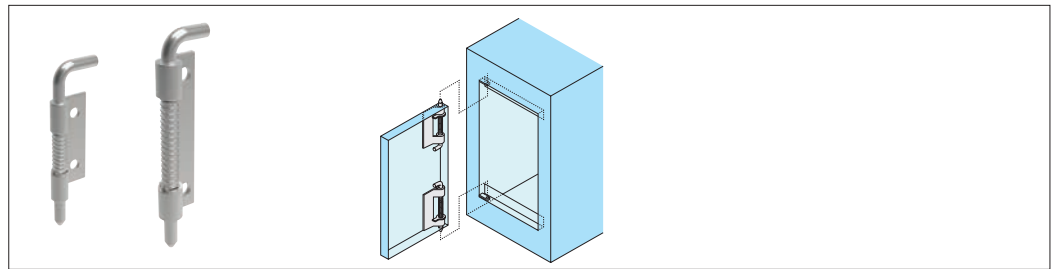

End mount concealed pivot hinges

Door removal hinges

Door removal or lift-off hinges simplify removal of covers and panels to ease access for maintenance and repair, available in a selection of materials.

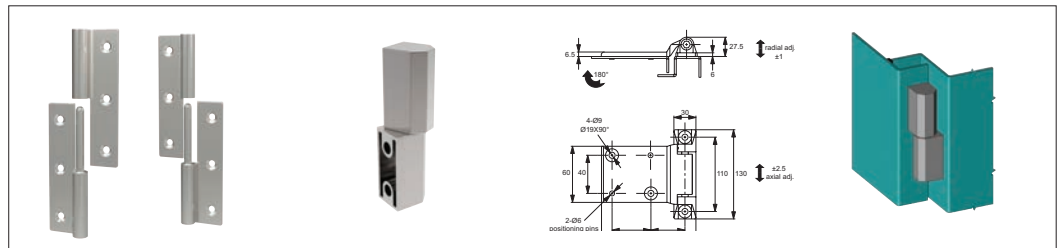

Lift off hinges

Torque and positioning hinges

Torque and positioning hinges offer positive location of panels, screens and displays using constant friction for a firm hold.



Constant torque hinges

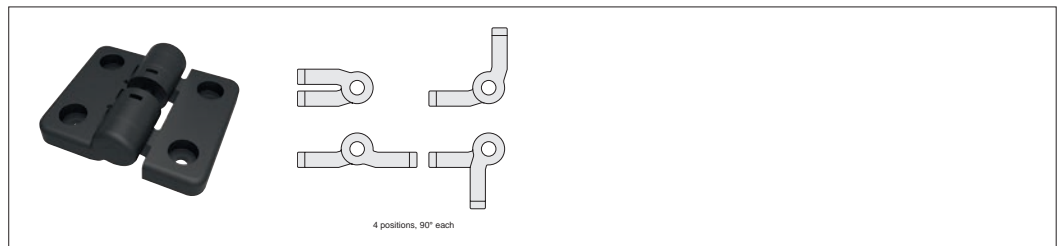

Detent positioning hinges

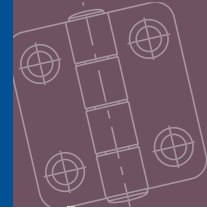

Wixroyd have a diverse range of hinges to suit most industrial applications in a wide range of materials and finishes.

Throughout our catalogue we refer to parts as being of a "Left" or "Right" type or hand. Which type you need, is most easily explained as follows;

Oriente your application so that when opened the door/panel comes towards you. With this orientation in mind, look to see on which side of the door/panel the hinges are mounted?

If the hinges are on the left side of the door/panel then you require "Left" type products. If the hinges are on the right side of the door/panel then you require "Right" type products.

The illustration on the right clearly indicates the layout and orientation of the door where a "left" or "right" product is used.

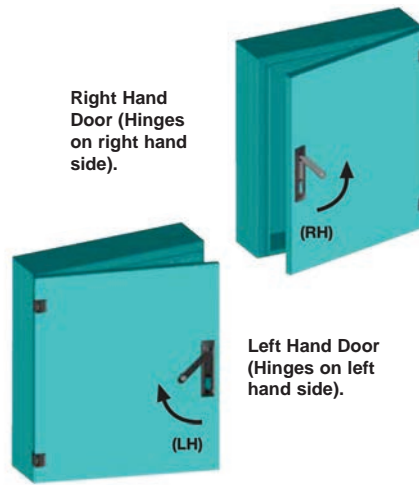

**Left or right type:
Which do you need?**

Hinges

External or surface mount hinges have a wide range of application on electrical panels, sheet metal enclosures, generators and heating and venting applications.

External hinges

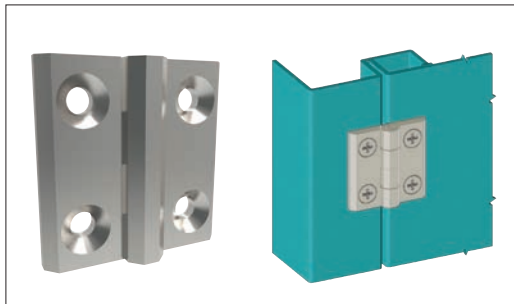

Surface mount hinges

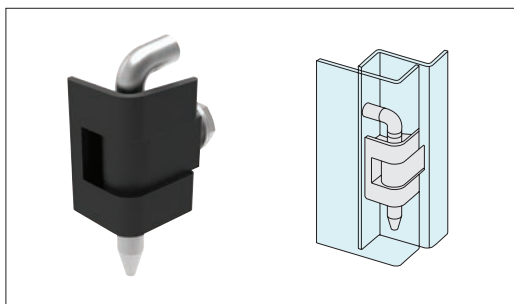

Corner hinges

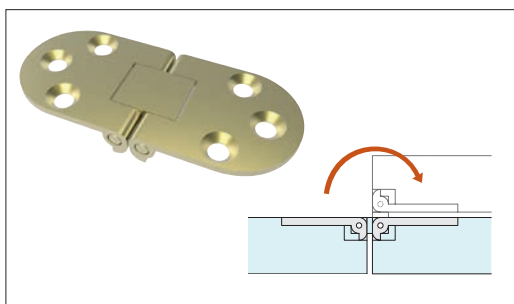

Flush mount hinges

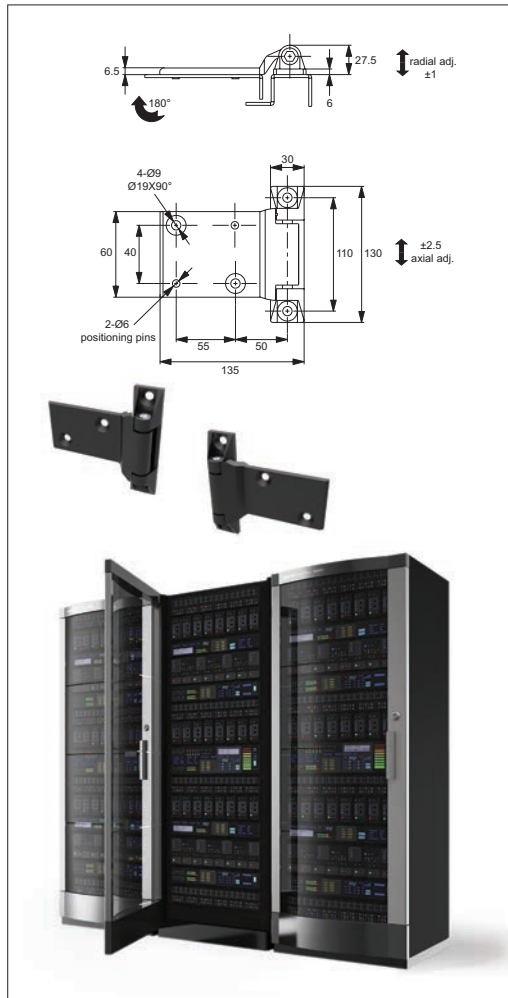

Surface mount hinges

HINGES

ov-WS0050-A-T-WS2300-A-TH1200-wide-range-of-solutions-b-rnh - Updated - 01-11-2022