



Surface Mount - Leaf Hinges

integrated stud - zinc



Hinges

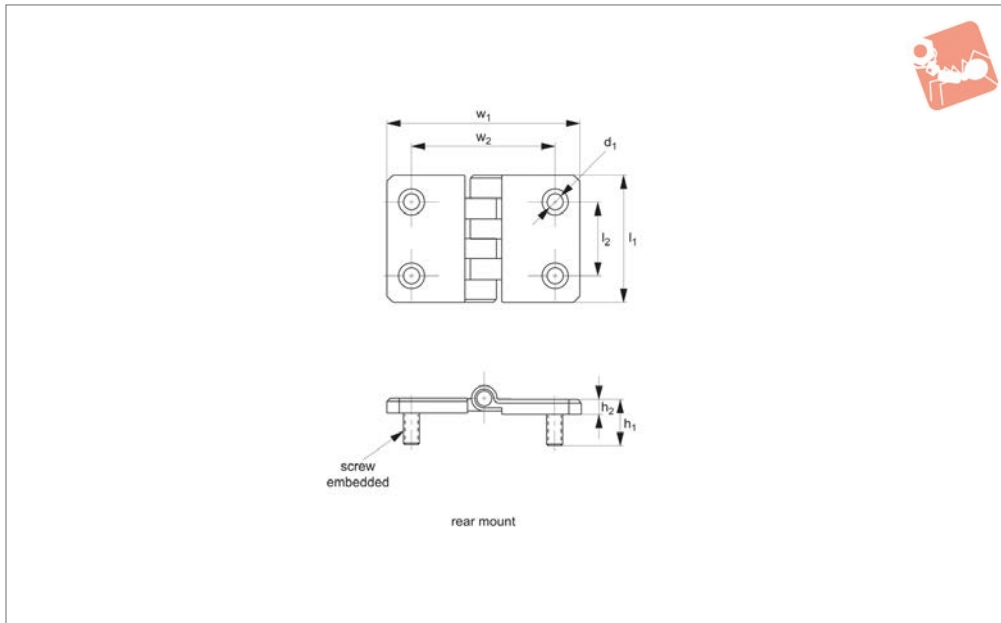

S1136

HINGES

Material

Hinge: die cast zinc, chrome plated or black powder coated.

Pin: steel

Technical Notes

Opening angle 180°.

Order No.	Finish	Mount	h_1	h_2	l_1	l_2	w_1	w_2	F_x kN	F_y kN	d_1
S1136.AW0020	Chrome	Rear	20.5	7	54	38	40	26	1.5	1.8	M6
S1136.AW0320	Black Coated	Rear	20.5	7	54	38	40	26	1.5	1.8	M6
S1136.AW0030	Chrome	Rear	21.0	6	50	30	76	56	1.125	1.49	M6
S1136.AW0330	Black Coated	Rear	21.0	6	50	30	76	56	1.125	1.49	M6

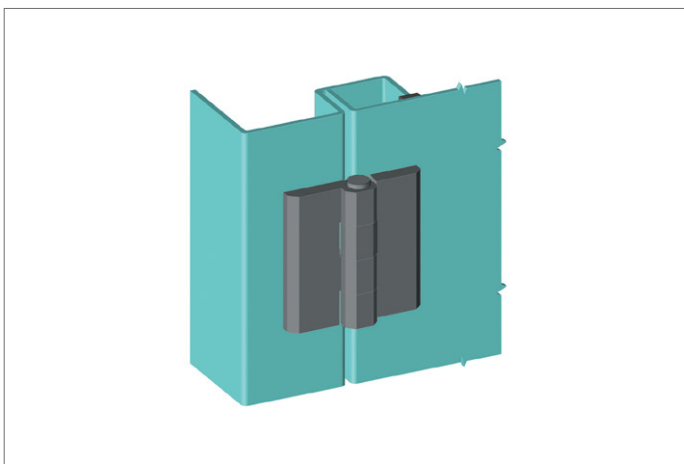



Concealed hinges

For added security or a sleek enclosure design, concealed hinges offer the solution with mounting discreetly hidden away from view to avoid tampering.

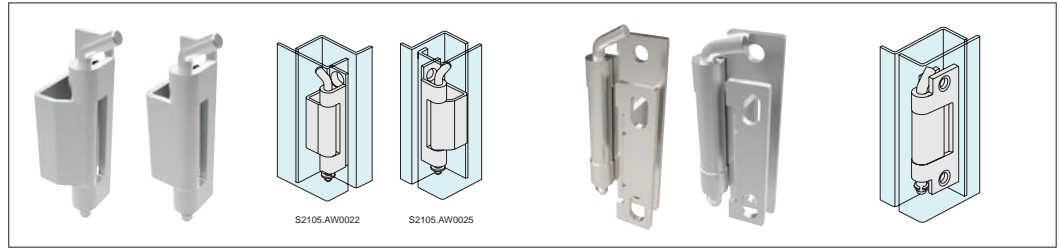

Concealed pivot hinges

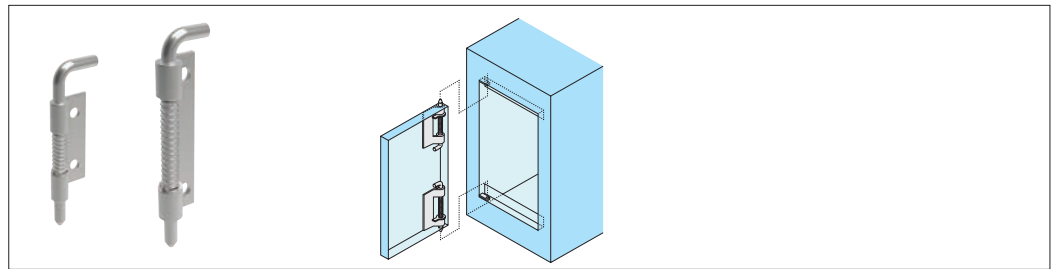

End mount concealed pivot hinges

Door removal hinges

Door removal or lift-off hinges simplify removal of covers and panels to ease access for maintenance and repair, available in a selection of materials.

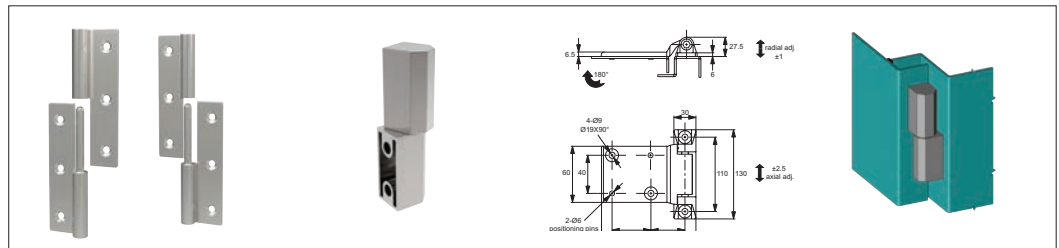

Lift off hinges

Torque and positioning hinges

Torque and positioning hinges offer positive location of panels, screens and displays using constant friction for a firm hold.



Constant torque hinges

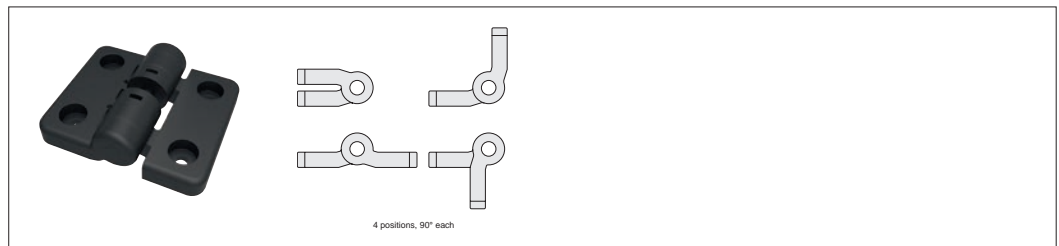

Detent positioning hinges



Wixroyd have a diverse range of hinges to suit most industrial applications in a wide range of materials and finishes.

Throughout our catalogue we refer to parts as being of a "Left" or "Right" type or hand. Which type you need, is most easily explained as follows;

Oriente your application so that when opened the door/panel comes towards you. With this orientation in mind, look to see on which side of the door/panel the hinges are mounted?

If the hinges are on the left side of the door/panel then you require "Left" type products. If the hinges are on the right side of the door/panel then you require "Right" type products.

The illustration on the right clearly indicates the layout and orientation of the door where a "left" or "right" product is used.

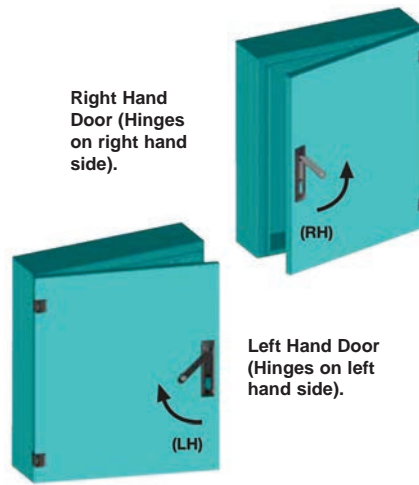

**Left or right type:
Which do you need?**

Hinges

External or surface mount hinges have a wide range of application on electrical panels, sheet metal enclosures, generators and heating and venting applications.

External hinges

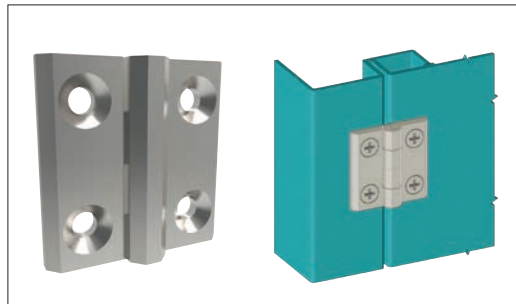

Surface mount hinges

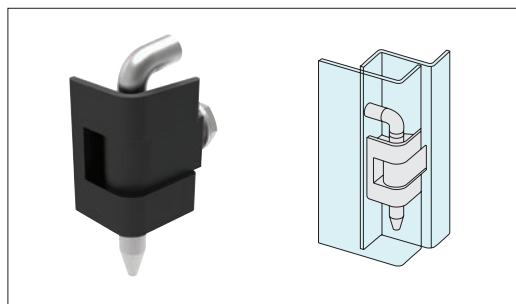

Corner hinges

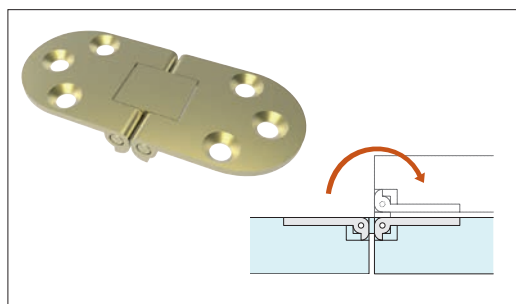

Flush mount hinges

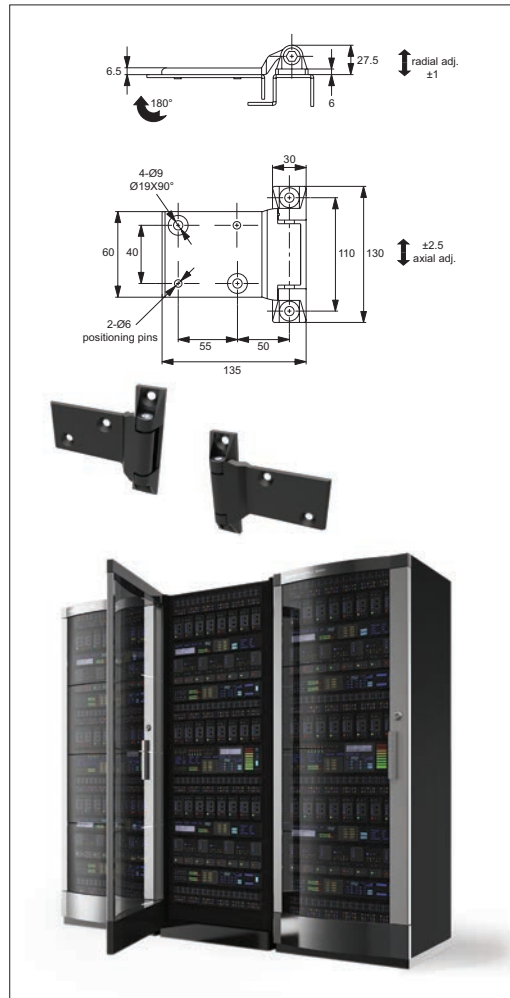

Surface mount hinges

HINGES

ov-WS0050-A-T-WS2300-A-TH1200-wide-range-of-solutions-b-rnh - Updated - 01-11-2022