

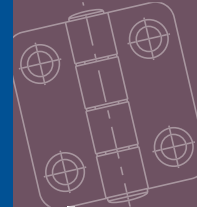

Constant Torque Hinge

dual axis fringe - screw mount - stainless



Hinges

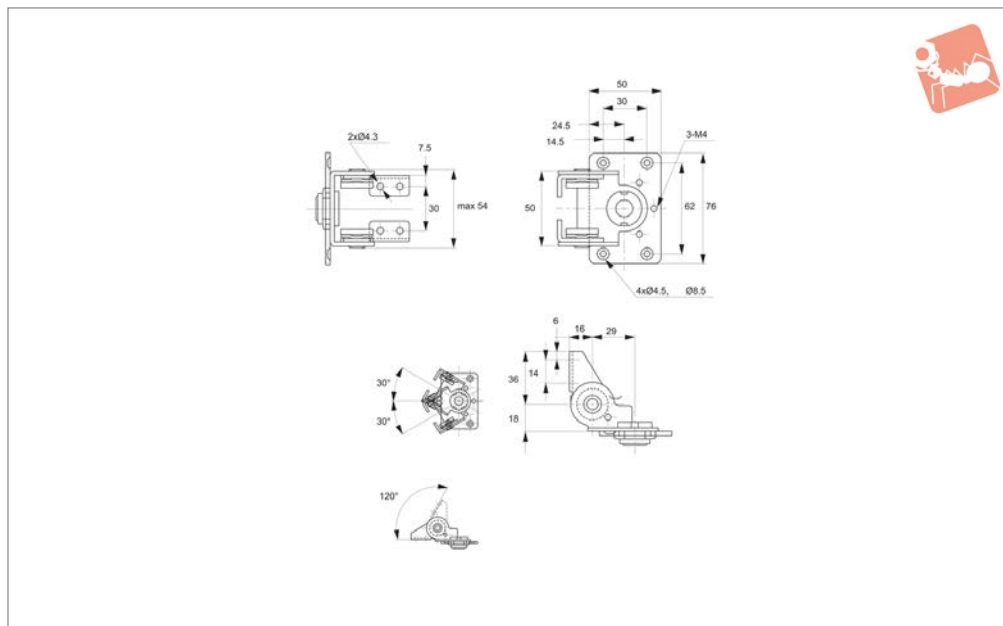

S4032

HINGES

Material

Body and base: stainless steel, AISI 430.

both axis. Ideal for mounting of monitor screens. Angle of swivel axis can be limited via use of pin/screw (not supplied).

Technical Notes

Dual axis torque hinge with stability in

Order No.	Swivel angle	Swivelling torque kgf/cm ±20%	Tilting angle	Tilting torque kgf/cm ±15%
S4032.AC0030	30°/90°	30.5	120°	71.5

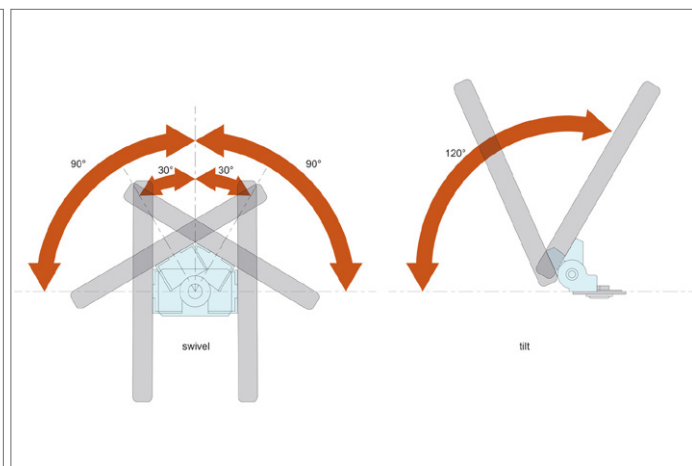
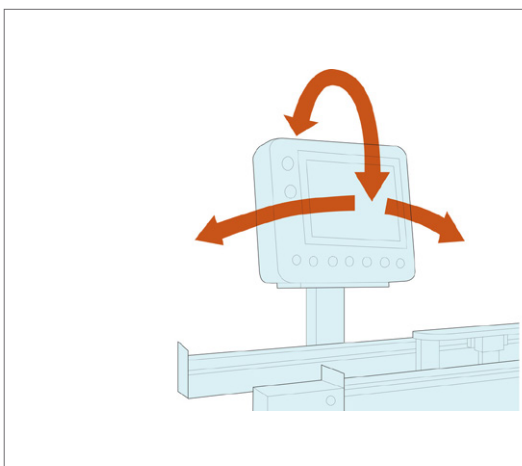

























Table of constant torque ranges					Torque Nm													
Part no.	Torque type	Shaft Rotation	Torque Nm		0,5	1,0	1,5	2,0	2,5	3,0	3,5	4,0	4,5	5,0	5,5	6,0	6,5	7,0
 S3810	Symmetric	360°	0,05 to 3,80		[Bar chart showing torque range from 0.05 to 3.80 Nm]													
 S3820	Symmetric/Asymmetric	360°	0,2 to 1,1		[Bar chart showing torque range from 0.2 to 1.1 Nm]													
 S3824	Symmetric/Asymmetric	360°	0,2 to 1,1		[Bar chart showing torque range from 0.2 to 1.1 Nm]													
 S3830	Symmetric/Asymmetric	270°	0,9 to 3,4		[Bar chart showing torque range from 0.9 to 3.4 Nm]													
 S3834	Symmetric/Asymmetric	270°	0,9 to 3,4		[Bar chart showing torque range from 0.9 to 3.4 Nm]													
 S3840	Symmetric/Asymmetric	270°	0,9 to 3,4		[Bar chart showing torque range from 0.9 to 3.4 Nm]													
 S3844	Symmetric/Asymmetric	270°	0,9 to 4,5		[Bar chart showing torque range from 0.9 to 4.5 Nm]													
 S3850	Symmetric/Asymmetric	270°	0,9 to 3,4		[Bar chart showing torque range from 0.9 to 3.4 Nm]													
 S3852	Symmetric/Asymmetric	270°	0,9 to 3,4		[Bar chart showing torque range from 0.9 to 3.4 Nm]													
 S3854	Symmetric/Asymmetric	270°	0,9 to 4,5		[Bar chart showing torque range from 0.9 to 4.5 Nm]													
 S3860	Symmetric	270°	3,5 to 7,0		[Bar chart showing torque range from 3.5 to 7.0 Nm]													
 S3870	Symmetric	90° and 360°	2,5 to 5,0		[Bar chart showing torque range from 2.5 to 5.0 Nm]													

Constant Torque Hinges S4000-S4032

Operating Principle

Wixroyd Constant Torque Hinges rely only on mechanical friction to achieve a stable torque. A range of different friction hinges are available to best suit your application.

Table of constant torque ranges				Torque Kgf.cm															
Part no.	Torque Kgf.cm			10	20	30	40	50	60	70	80	90	100	110	120	130	140	150	
 S4000	5 - 57.5			[Bar chart showing torque range from 5 to 57.5 Kgf.cm]															
 S4002	8			[Bar chart showing torque range from 8 to 8 Kgf.cm]															
 S4006	3.5 - 15.3			[Bar chart showing torque range from 3.5 to 15.3 Kgf.cm]															
 S4010	15 - 30			[Bar chart showing torque range from 15 to 30 Kgf.cm]															
 S4016	25 - 70			[Bar chart showing torque range from 25 to 70 Kgf.cm]															
 S4020	20 - 45.8			[Bar chart showing torque range from 20 to 45.8 Kgf.cm]															
 S4022	20 - 45.8			[Bar chart showing torque range from 20 to 45.8 Kgf.cm]															
 S4030	Tilting: 30.5 Swivelling: 15			[Bar chart showing torque range from 15 to 30.5 Kgf.cm]															
 S4032	Tilting: 71.5 Swivelling: 30.5			[Bar chart showing torque range from 30.5 to 71.5 Kgf.cm]															