

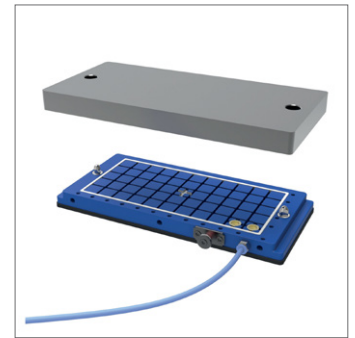

VacMagic VM100 Palletising System

for quick fixture change

Vacuum Clamping Systems

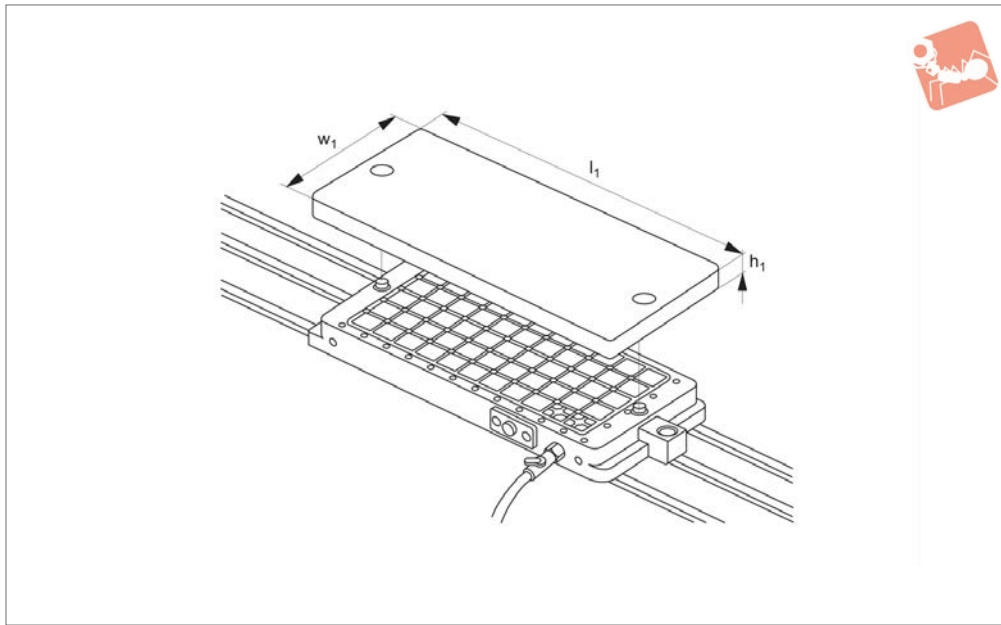

19710

VACUUM CLAMPING SYSTEMS

Technical Notes

Use as a quick fixture palletising system - blank pallets available, see part no. 19710.W0325.

Mount to grid plate or T-slot table with clamps provided.

Operates from 70-100 psi shop air, no need

for vacuum pumps and coolant traps.

Will accept the standard 19730.W0150 vacuum pallet, increasing your vacuum platform to over 360mm x 315mm.

Remove 12mm pins for grinding/ machining thin material, use set screws to locate and aid in holding force.

Tips

Clamp in a vice to reduce setup time.

Important Notes

Set includes everything necessary to get your 19710 running within minutes of opening the box - excludes regulator.

Order No.	Description	l_1	h_1	w_1
19710.W0110	Gasket - Black per foot	-	-	-
19710.W0114	Gasket - White per foot	-	-	-
19710.W0300	Complete System - Base, 2 Pallets and Clamps	-	-	-
19710.W0325	Blank Pallet	318	25	150
19710.W0375	Base and Clamps	315	25	140



Applications

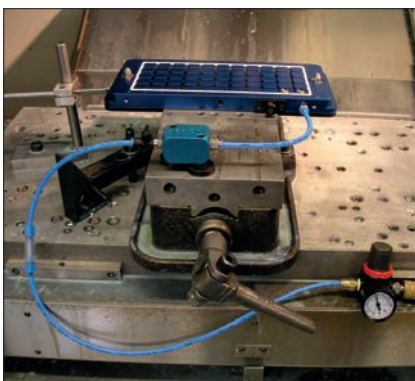

More than just a vacuum system - a fully flexible clamping and fixturing solution.

Mount the base unit to the grid plate, T-slot table or in a vice.

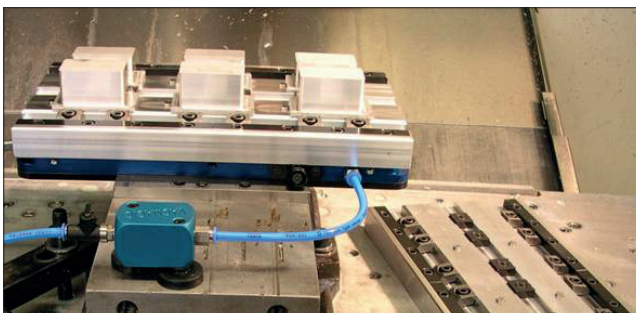

Make your own vacuum fixtures for fully flexible fixturing.

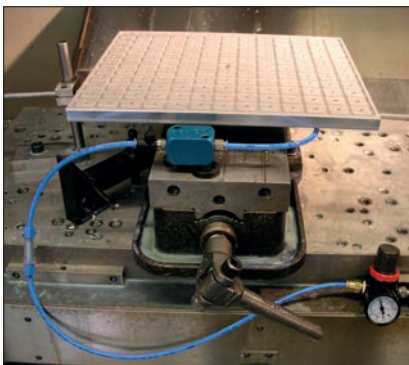

Will accept the standard 19730.W0150 pallet, increasing your vacuum platform to over 360 x 315mm.



Sliding stop 12042 used to assist in low profile positioning on our vacuum system.



Maintenance

Very little maintenance is necessary to keep your system up and running. Using general housekeeping practices will ensure your system operates properly for years to come.

- Brass filters may require periodic cleaning to prevent clogging and airflow obstruction. Remove the filters, soak in a cleaning solvent, and apply compressed air from the rear of the filter. This should be done in a safe manner to avoid personal injury to yourself or others. Then, simply dry and re-install the filters.
- The Venturi generator may become obstructed with foreign objects or blocked up by coolant if the system has not been used for a while. Simply remove the supply valve and check/remove any small objects that may be interfering with the air supply. While the supply valve is removed, use a 0,9mm pin to clear any debris build-up that may have accumulated in the Venturi generator (see image below).
- The low vacuum indicator may also require periodic cleaning. Remove this and clean with light oil before re-installing.
- A visual inspection of all O-rings and white gasket material should be done on a regular basis: O-rings monthly, white gasket material weekly.

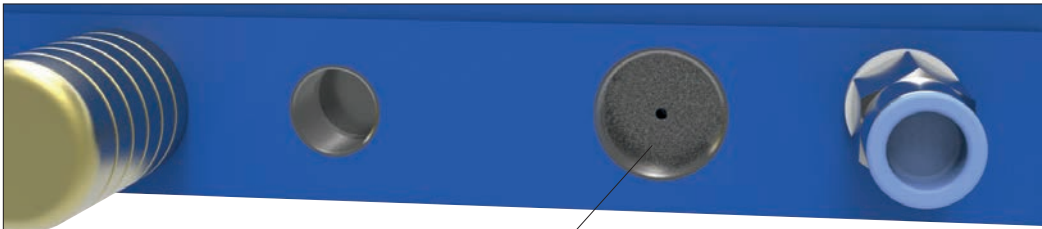

Supply valve removed exposing Venturi generator

Troubleshooting

This is a very simple operating system. Any problems can be easily rectified with the information contained in this manual or by contacting us directly.

- Check air pressure.
- Ensure gasket material is protruding above the fixture plate and continuous with no gaps.
- Clean brass filters.
- Check front of Venturi generator for obstructions.
- Ensure locating pins are fully seated (diamond and solid).
- Through hole for vacuum pallets should be a minimum of 0.25 inch diameter.
- Check that all top plate mounting bolts are tight and below the surface of the plate.
- Check air lines for leaks.
- Check workpiece for flatness.
- Check exhaust air for restricted flow.

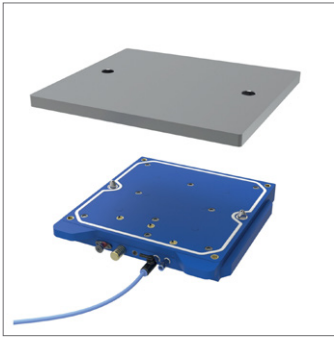

19730

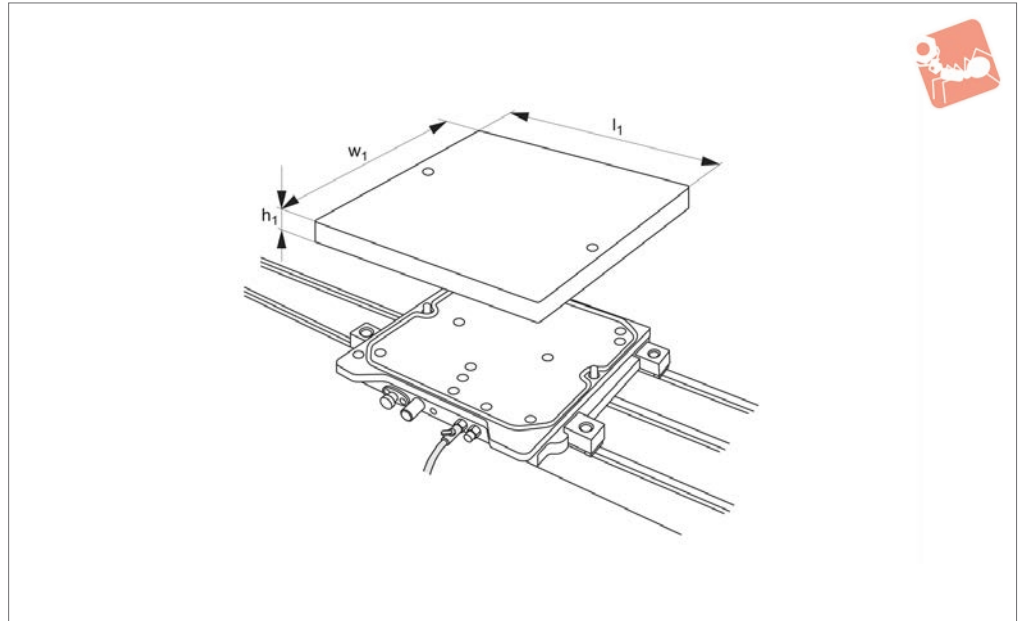

Technical Notes

Can be used as a traditional vacuum system and for a rapid fixture change system. For vacuum application use the standard vacuum grid pallet or use with the blank pallets machined to suit custom parts. Alternatively, use as a quick fixture change system. Pallets can be swapped in 30 seconds or

less. Load pallets while machining to maximise productivity. Easy to install and set up. Virtually maintenance free - reliable and easy to use. Flexible pallet design. No pumps - use standard shop air. Air supply requirements 70-100 psi. Low pressure safety switch, vacuum indicator, hardened locator pins all included.

Tips

Vacuum pallet 19730.W0150 is machined with cross slots to receive vacuum sealing gasket and machined with M 6 holes for fixing of stops such as sliding stop 12042.W0200. Spare parts readily available, please see replacement parts page.

Order No.	Description	l_1	h_1	w_1	Weight kg
19730.W0101	Complete System Includes: Base Unit, 2 Blank Pallets, 1 Vacuum Pallet	-	-	-	25.5
19730.W0130	Blank Pallet	360	19	315	
19730.W0131	Blank Pallet (1" thick)	379	25	379	5.0
19730.W0150	Vacuum Pallet with M 6 Threaded Holes	360	16	315	14.5
19730.W0160	Large Vacuum Pallet	859	16	368	12.0
19730.W0175	Base (Receiver) - Includes Safety Switch, Required Hoses	323	35	330	25.8



Applications

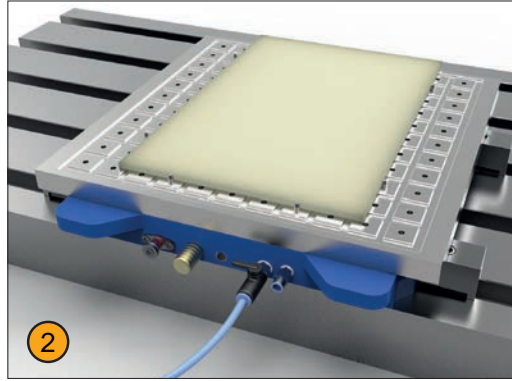
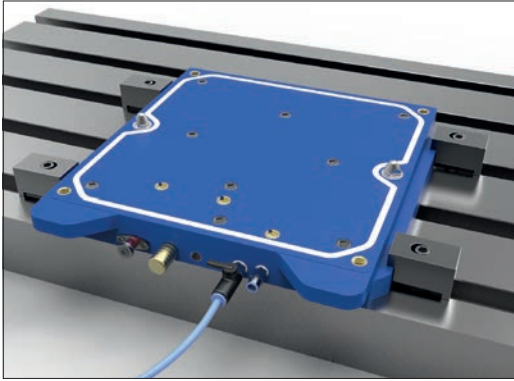

- Quick change
- Maximise productivity
- Easy installation
- Precise repeatability
- Reliable and easy to use
- No pump required

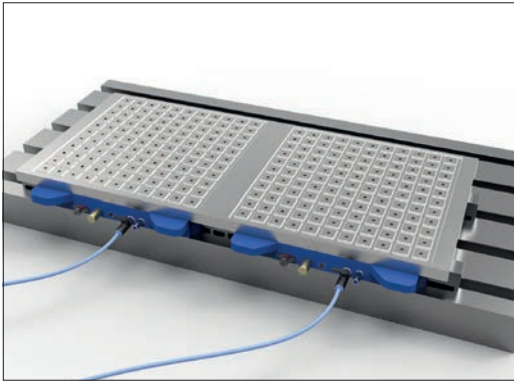

- 1 Low profile base unit quickly mounts to machine table. Operates with standard 70 psi workshop air.
- 2 Workpiece placed over rubber gasket and pushed down to create a vacuum. Now ready for machining.
- 3 Two systems placed next to each other for holding larger pieces.

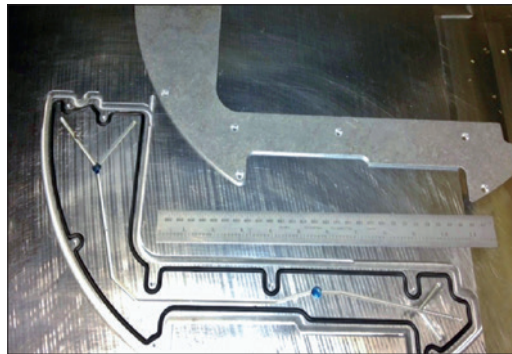
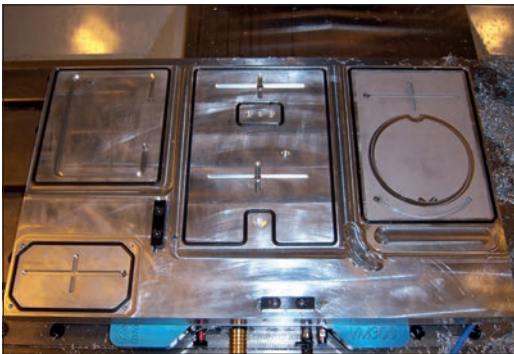
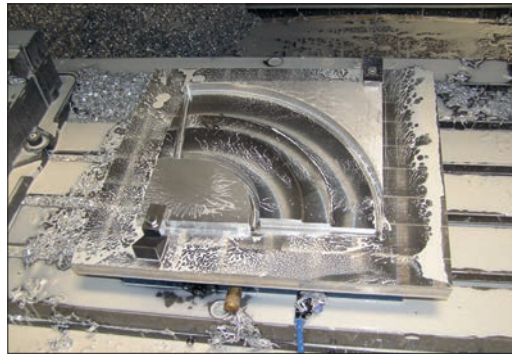
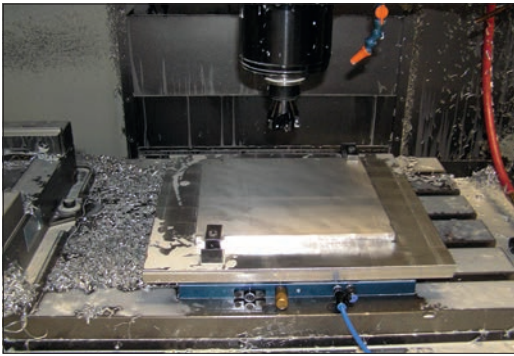



Contents

- 1 Base unit (19730.W0175)
- 2 Vacuum pallet (19730.W0150)
- 3 Blank pallet x2 (19730.W0130)
- 4 Special mounting washers x4 (MB45055)
- 5 Low pressure trip switch (LPTS) (MB45040)
- 6 4mm & 6mm supply line (MB45080 and MB45085)
- 7 Base unit mounting clamps x4 (MB22851)
- 8 LPTS mounting screws x2, FHCS for alignment pins x2
- 9 10 ft. gasket material (black) (MB45110)
- 10 Extra O-rings x3 (MB45045)
- 11 Base alignment pins x2 (MB45075)
- 12 4mm & 6mm tubing mounting brackets x2
- 13 6mm supply line regulator fitting (MB45050)
- 14 Inline filter (MB45015)

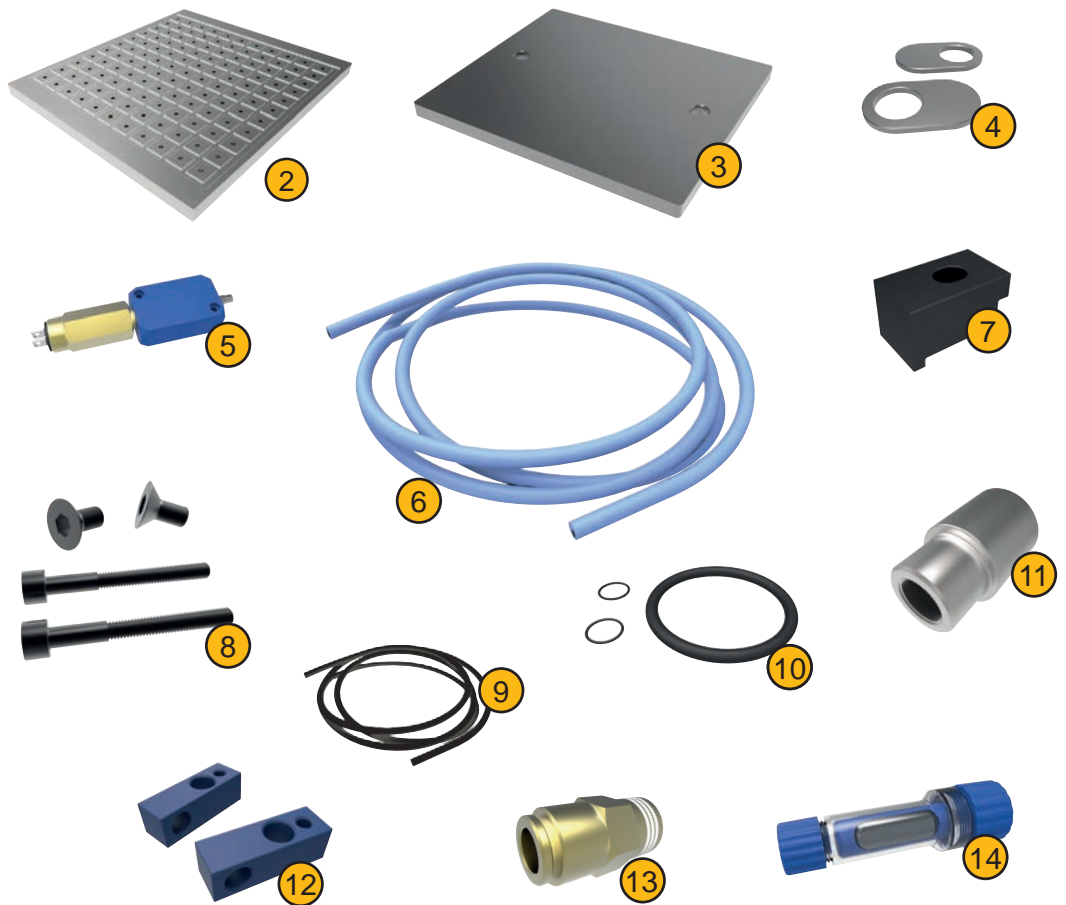
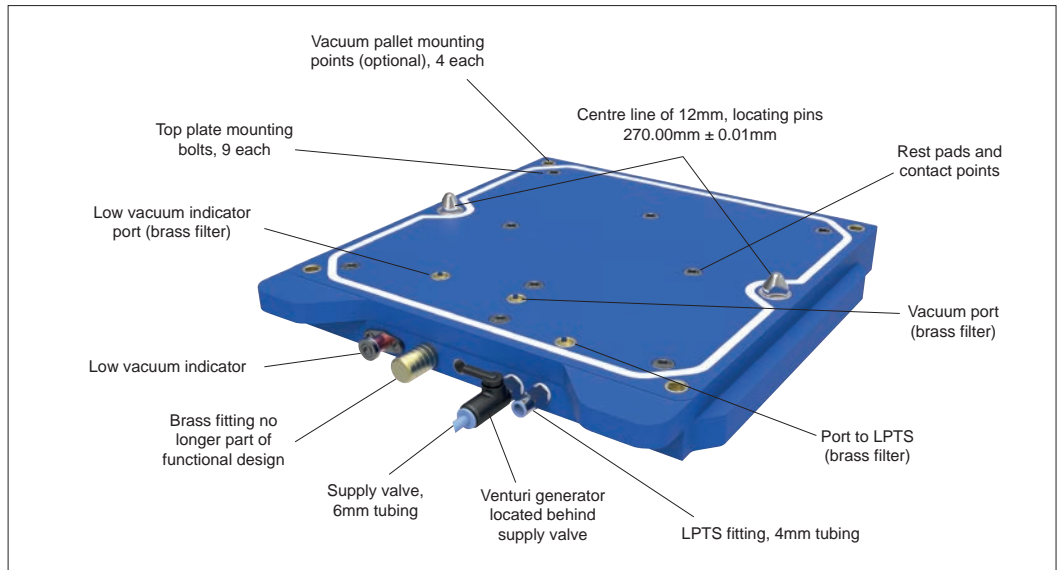



VacMagic VM300 - 19730

mounting the base unit

Clamping & Height Setting

Quick and Easy to Use with Every Load

- 1) Identify the locating pins and secure with 4 mounting clamps.
- 2) Baseplate is now ready for connection of air supply.

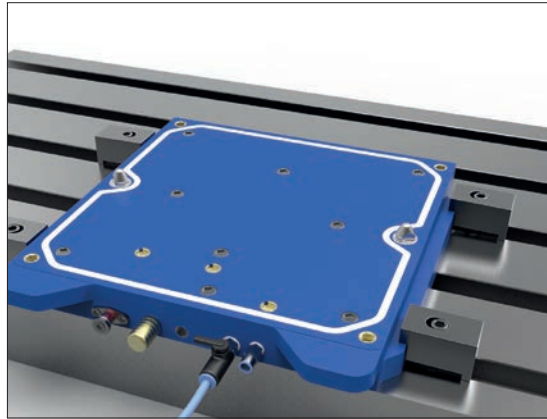

Option 1 - Preferred Method for Mounting the Base Unit

- 1) Remove 6mm bolts (2 each), securing locating pins from the bottom side of the unit, and loosen top plate mounting bolts. Remove locating pins, mounting bolts and top plate.
- 2) Identify the base plate and secure using special mounting washers.
- 3) Prior to installing top plate, ensure there are no foreign objects on either of the mating surfaces and all three O-rings are properly seated. Install top plate and loosely install mounting screws.
- 4) Insert locating pins and adjust diamond pin 90° to solid pin. Please be aware there is no practical method of installing the 6mm bolts used to secure the locating pins once the base is mounted. (A sub-plate with clearance holes may be used if necessary.)
- 5) Securely tighten all top plate mounting bolts.

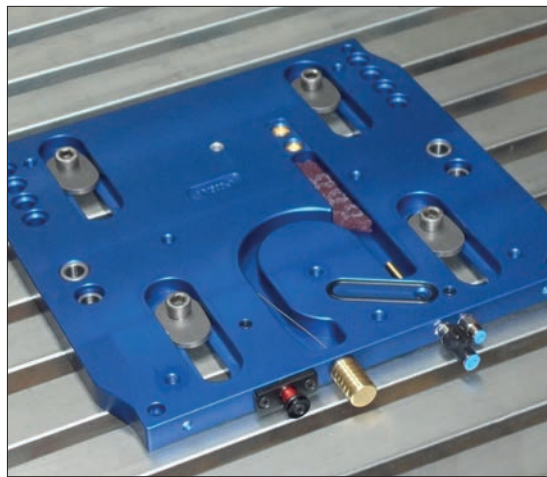

Option 2 - Mounting Using Internal Slots

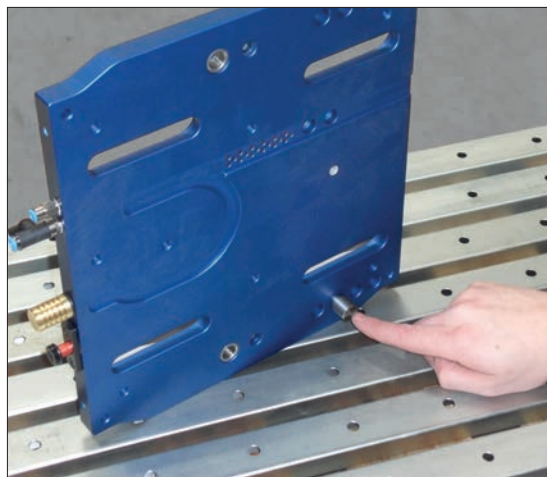

Important Note: One loose top plate bolt may interfere with pallets precisely locating on rest pads, preventing 100% vacuum.

Option 2 may be necessary if mounting more than one unit side-by-side.

Base alignment pins may be installed to locate off T-slots or precise bores in sub-plate. Remove top plate and secure with provided mounting screws.

- 6) Base plate is now ready for connection of the air supply.

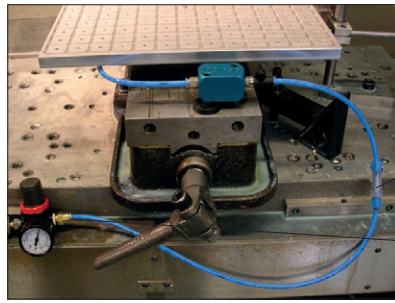

The in-line filter is provided to help prevent blockages in the air supply.

In-line filter

Regulator fitting

Manual Machines

Note: Air requirements should be between 70-100 psi with a minimum flow of 2 cfm. Pressure below 70 or above 100 psi will reduce maximum vacuum force.

- 1) Install regulator fitting to regulator. Connect 6mm blue tubing to front of base unit (supply valve) and regulator fitting. Mounting brackets are included to aid in routing lines.
- 2) Secure tubing close to the base unit to prevent undue stress on supply valve.
- 3) Place blank pallet on unit, turn on supply valve. Vacuum indicator retracts. (Refer to troubleshooting section if indicator is not fully recessed).

System is ready for use.

Perform steps 1-3 above for manual machines

- 4) Remove power from the machine.
- 5) Mount the low pressure trip switch (LPTS) at convenient location, usually to the rear of the machine.
- 6) Connect 4mm blue tubing to the front base unit and fitting on the LPTS.
- 7) Connect the LPTS in series with the selected cut-off circuit.
- 8) Restore power and check all the air connections for leaks.
- 9) Adjust the trip screw located on top of the LPTS between the two prongs; synchronise with the low vacuum indicator on the front of the base unit.



Low Pressure Trip Switch (LPTS) Important Note:

Method of synchronising the LPTS with the low vacuum indicator: With LPTS connected to the door switch interlock, slowly reduce the airflow with the supply valve until the low vacuum indicator starts to protrude. At this point, adjust the trip screw until the machine shuts down. Increase the airflow and the machine will resume function. This should be done several times to ensure the settings are optimised.

System is ready for use.

Review Checklist Prior to Use

- Base unit is identified and securely mounted to the machine table.
- Top plate bolts are tight.
- Check all air lines for leaks.
- Air supply is 70-100 psi.
- Low vacuum indicator is operating properly.
- LPTS is operating properly (if installed).



Custom Vacuum Pallets

When using the blank pallet to design your custom pallets, we recommend a quick look at some examples sent in by customers. Feel free to submit photos of your application - we love to see what our customers can do with our products.

Machining dimension for the white gasket material: 0.142" wide x 0.138" deep, bottom of slot to be square.

One through hole is required for each vacuum chamber, minimum diameter 0,25 inch. We suggest an aggressive countersink on the bottom side of the pallet and the top should be in a slot, channel or pocket. Avoid through hole being directly over rest pads on base unit (see image on right).

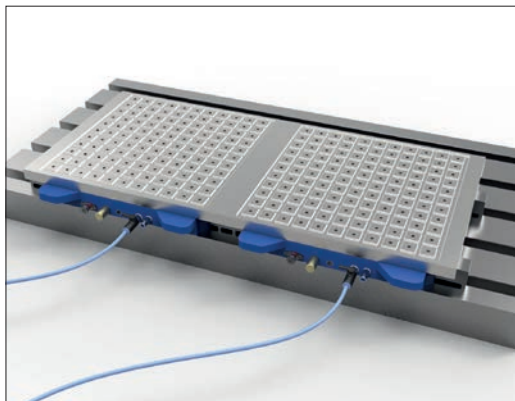
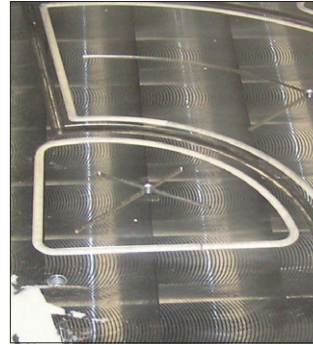

Twin vacuum setup

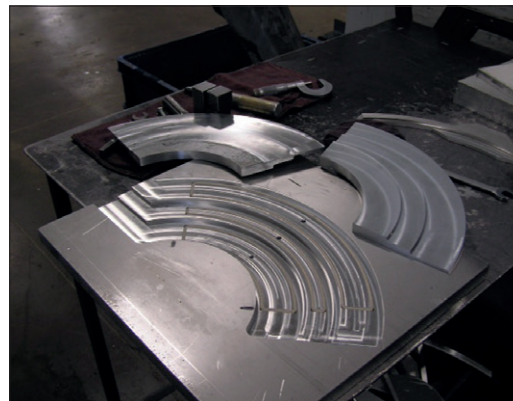

Create custom vacuum pallets for specific applications

Additional Information

- The Venturi generator produces a vacuum of approximately 12-13 psi.
- Increasing friction between your workpiece and the vacuum pallet will provide additional resistance against lateral movement. Using an adhesive-backed "sandpaper" product on the vacuum plate or pins with sharp points protruding slightly above the surface will aid in difficult applications.
- When using more than one system for large applications, we recommend that you do not connect them to each other. Rather, keep each separate system running independently.
- Apply a small amount of silicone to secure the white gasket material in the slot. A very small gap is all that is required, so as not to interfere with compression characteristics.
- When using the VacMagic as a pallet changer or when a vice is mounted to a blank pallet, aggressive machining operations can be performed. In this configuration the vacuum being produced is approximately 1,500 lbs. What makes the unit so strong is the two 12 mm locating pins that would have to bend or snap to break the vacuum seal.
- The standard vacuum pallet has 140 holes (4mm) that can be used for locating pins or small edge clamps.

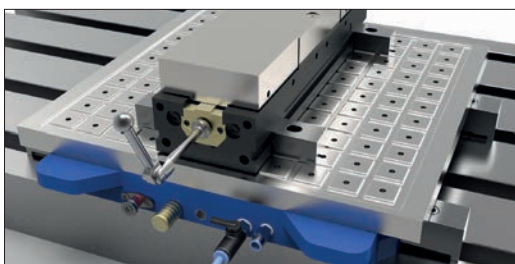

Mounting a vice on the blank pallet will eliminate the time it previously took to clock it in. Fixture plate.

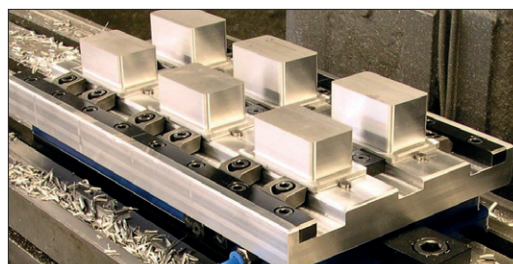



Replacement Parts for 19730 VacMagic VM300

For advice and ordering of these parts please contact our technical department.

Description	Part No.
Brass filter	MB45010
In-line filter	MB45015
Mounting bracket with 4mm & 6mm holes	MB45020
Locating pins (1 tapered & 1 diamond)	MB45025
Low vacuum indicator with spring	MB45030
Spring for low vacuum indicator	MB45031
Low pressure trip switch (LPTS)	MB45035
Low pressure trip switch assembly (LPTS)	MB45040
"VacMagic O-rings" (3/pk, 2 small & 1 large)	MB45045
Supply valve	MB45050
Special mounting washer	MB45055
LPTS fitting (base unit)	MB45060
LPTS fitting (block)	MB45065
Bushings for custom pallets (2/pk)	MB45070
Base alignment pins (2/pk)	MB45075
4mm blue tubing (15 ft/pack)	MB45080
6mm blue tubing (12 ft/pack)	MB45085
6mm tubing QD fitting for regulator	MB45090
Assorted hardware for location pins, alignment pins & LPTS block	MB45095
VacMagic system including 1 vacuum pallet, 2 blank pallets & 4 mounting clamps	19730.W0101
Vacuum gasket 0,170" dia. (5 ft/pack) - black (for long machine cycles & aggressive coolants)	MB45110
Vacuum gasket 0,170" dia. custom lengths (by the ft) - black (for long machine cycles & aggressive coolants)	MB45111
Vacuum gasket 0,125" dia. (5 ft/pack) - black (for long machine cycles & aggressive coolants)	MB45118
Vacuum gasket 0,170" dia. (by the ft) - white (for small parts, water based coolants or dry running)	MB45114
VacMagic blank pallet	19730.W0130
VacMagic vacuum pallet	19730.W0150
VacMagic base unit including 4 mtg clamps	19730.W0175
Large mounting clamp	MB22815

Overall Dimensions for Units and Parts

	Dimension	Imperial	Metric
Base Unit	Height	1.375"	35mm
	Width	12.75"	323mm
	Length	13.00"	330mm
Standard Pallet	Height	0.75"	19mm
	Width	14.20"	360mm
	Length	12.4"	315mm
Vacuum Pallet	Height	0.63"	16mm
	Width	14.20"	360mm
	Length	12.40"	315mm



Vacuum Palletising and Clamping System



Clamping & Height Setting

It is over 10 years since the VacMagic palletising system was a workholding solution award winner at the MACH exhibition, and its relevance in prototype and early production run manufacturing is still as strong today as its innovation was 10 years ago.

Introduction to Vac Pallet Systems

Vacuum palletisation will reduce your setup times and maximise your production runs!

VM300 - Simple and easy to use, has the ability to switch from pallet changer to vacuum chuck in seconds to reduce setup time.

VacMagic Systems - Two Products in One

VM100 - Primarily designed for grinding non-ferrous material on a magnetic chuck, like its bigger brother (the VM300) it can be a pallet changer and a vacuum chuck.

Multi-Power Vac - Possibly the most multi-functional vacuum workholding system currently available.

Multi-Power Vac System

Compatible with CNC machines; vacuum clamping is cost-effective, increases productivity and minimises the potential of any clamping damage to the workpiece.

Why Choose a Vacuum System?

The VacMagic system enables high volume production runs at the same feeds and speeds as traditional pallet systems, with less setup time which reduces spindle downtime.

The low profile base unit of the VacMagic can be used either as a vacuum pallet or a standard pallet set up as a fixture plate for increased productivity. Alternatively, a standard vice can be mounted directly onto the VacMagic base for easy loading and unloading, eliminating the need to index the vice on each use – providing quick change over from prototype to production volumes.

Multi-Power Vac has a 400mm x 350mm grid plate base, tapped with M6 threads and a finely textured surface, which increases holding force through friction. The Multi-Power Vac therefore offers greater flexibility for multiple workholding solutions.

The vacuum system is ideally suited to anything that is difficult to hold, such as oddly-shaped objects, parts too thin for traditional workholding, or brittle and/or soft materials like graphite. It is an ideal alternative to a magnetic chuck for non-magnetic materials such as wood or plastic.

What Materials Can My Vacuum System Work With?

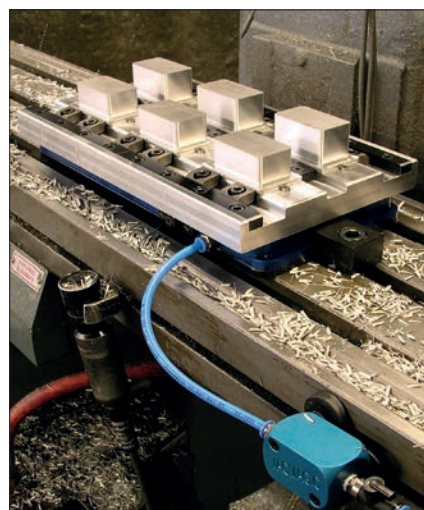
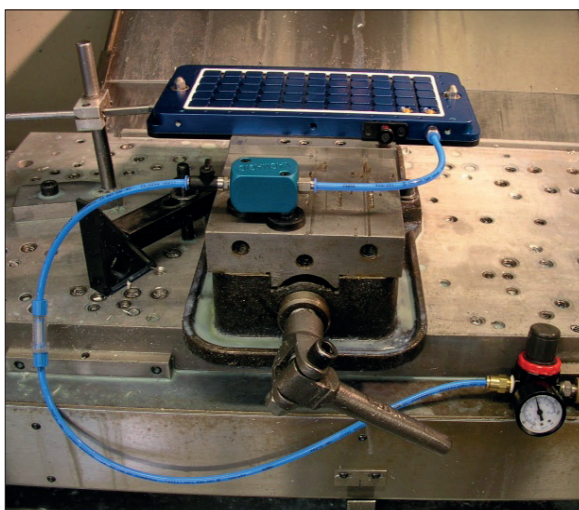

For a demonstration of our VacMagic and Multi-Power Vac Palletising and Clamping System.

Please call us on **0333 207 4497** or email sales@wixroyd.com

We look forward to helping you maximise your productivity.

What Can We Do For You?

ov-W19730-A-T-vacuum-palletising-and-clamping-system-rnh - Updated -25-10-2022

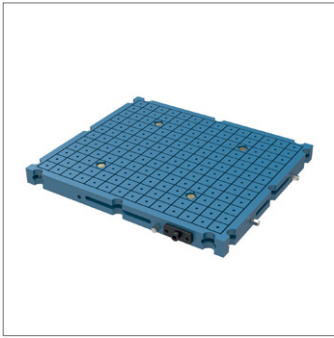

19740

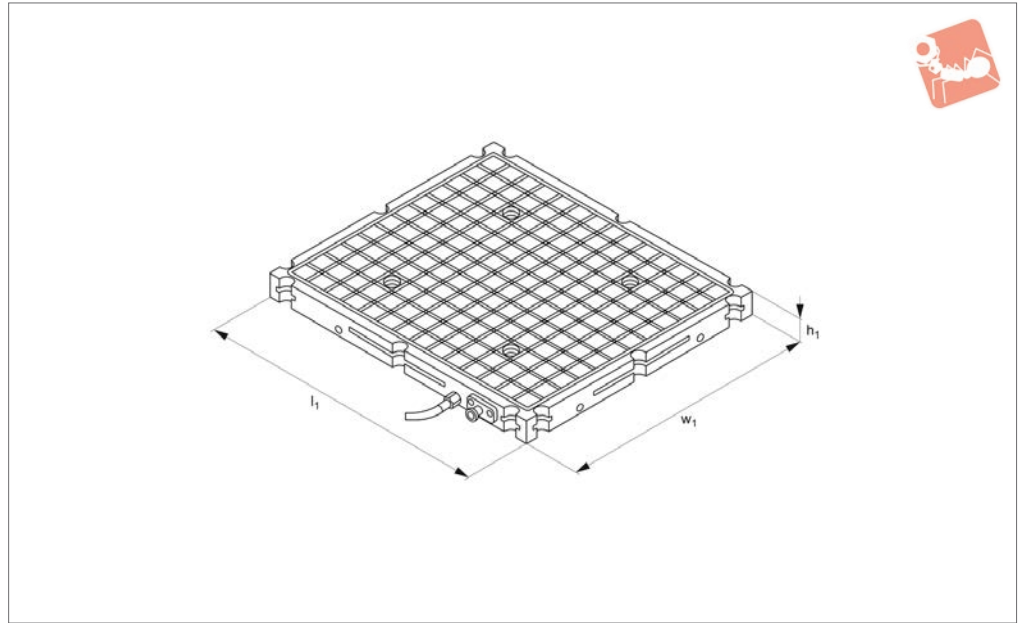

Technical Notes

Easy to install and set up vacuum workholding system.

We recommend use of a coolant trap (optional) when using an external vacuum source.

Tips

1. Receiver base 19740.W0200 is 406 x 355mm, with grid plate design to allow multiple workholding solutions. Textured surface generates additional holding force through friction.
2. Machined with cross slots to form grids

- of 23,6mm square, at 26,9mm spacing. Each grid machined with M6 x 0,8 holes for fixing of stops such as sliding stop 12042.W0200.
3. Cross slots (3,6mm wide x 3,5mm deep) accept sealing gasket around each grid. Flexible receiver base design with 4 vacuum ports allowing holding of 1 to 4 small parts, or 1 large part (vacuum ports can be plugged).
4. Six oversized steel washers machined below bottom surface of receiver means it can be used for grinding operation on a

- magnetic chuck.
5. Twelve recessed pockets on side of receiver base allow multiple bases to be linked together to make a single large vacuum table.
6. 12mm diameter locating pins on underside of receiver base at 270mm, centre line for easy location.
7. Can be powered with shop air (70-100 psi), or vacuum generator.
9. Eight location ports for vacuum source connection.

Order No.	Description	l_1	h_1	w_1	Weight kg
19740.W0000	Complete System Includes: Multi Vac Pallet, Vac Generator, Coolant Trap and Fittings.	406	31.7	355	15.0
19740.W0050	Coolant Trap with Hose and Fittings	-	-	-	1.5
19740.W0100	Vacuum Generator with Regulator, Filter and Push Fit Connections	-	-	-	1.0
19740.W0200	Multi Vac Plate Only. With Mounting Fittings and Tubing.	406	31.7	355	16.5
19740.W0250	Sacrificial Top Plate with Mounting Screws (406 x 355mm).	-	-	-	4.0



Application 1

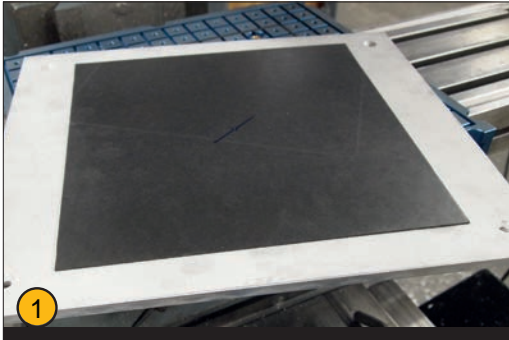

- 1 A custom "sacrificial plate" was made to cover the multi-power vacuum clamping plate for machining of thin and delicate parts.
- 2 Sacrificial plate is easily secured to multi-power vacuum clamping plate via four flat head screws.
- 3 To maximise the flexibility of the machining process, four multi-power vacuum clamping plates have been connected together and are run from one standalone vacuum pump. Here three very different components are being held; one long workpiece even stretches across two vacuum units.

Application 2

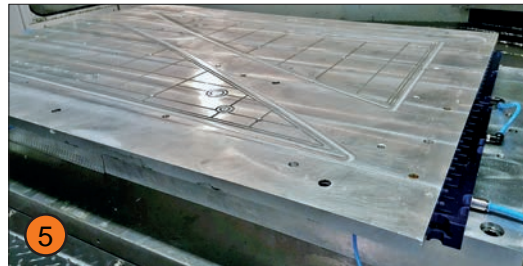
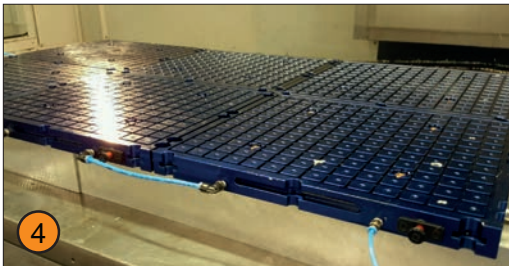

- 4 Multi-power vacuum clamping plates are suitable for large and small components. In this application six units have been connected together to achieve a very large clamping area of approximately 1200 x 700mm.
- 5 To hold delicate components, a custom pallet has been designed; vacuum ports were accessed through the pallet with a grid pattern to suit the component. Grid is sealed using supplied vacuum gasket to create vacuum seal.
- 6 Workpieces are aligned to the vacuum seal and loaded. Air supply is applied and workpieces are clamped ready for machining.

Why use the Multi-Power Vacuum plate?

- Cost-effective, versatile clamping that can be used for many applications.
- Quick setup and very easy to use.
- Minimises the likelihood of damage to the workpiece caused by other workholding methods.
- Compatible with CNC machines.
- Four suction ports allow multi-part clamping or a large surface area.
- Pre-drilled & threaded M6 holes for extra clamps or stops.

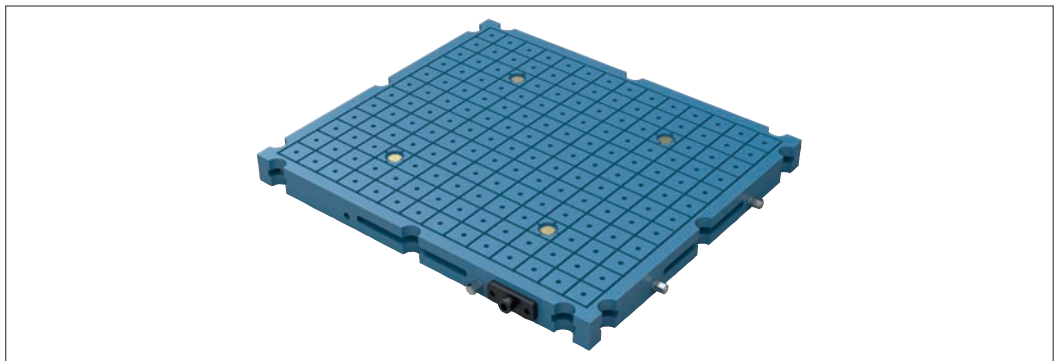

For a unique, universal clamping solution, look no further than Wixroyd's 19740 Multi-Power vacuum clamping plate. Equipped with several innovative features to meet your vacuum workholding needs.

Installation Overview

Summary

- Can be powered with our vacuum generator (19740.W0100) or can be run from machine shop air supply (70 psi).
- Base dimensions are 406mm x 355mm.
- 4 Vacuum ports allow up to four small parts or one large part to be held securely (ports can be plugged).
- M6 tapped threads integrated in the grid plate for versatile workholding solutions and / or more aggressive machining conditions.
- Multiple pallets can operate from a single vacuum generator.

Preferred Mounting Method

Simply mount the pallet using two mounting clamps. The pallet is now ready for the air supply to be connected.

Optional Mounting Methods

- Place pallet on magnetic chuck.
- Use locating pins & liners to precisely locate pallet onto sub-plate and secure with mounting clamps.
- For larger workholding solutions, link pallets connecting using the supplied washers.

Connection of Air Supply

The in-line filter is provided to remove contaminants from the air supply. Adjust the gas regulator (80-95 psi best). Common air connection fittings are provided.

Review Checklist Prior to Use

- Base unit is mounted to machine table.
- Air supply pressure is 70-100 psi.
- Air lines are connected and sealed.
- Low vacuum indicator is operating properly.

Maintenance

Very little maintenance is necessary to keep your system up and running. Using general housekeeping practices will ensure your system operates properly for years to come.

Troubleshooting

This is a very simple operating system. Any problems can be easily rectified with the information contained in this manual or by contacting us directly.

- Check air pressure.
- Ensure gasket material is protruding above fixture plate and that there are no gaps between the gasket and the plate.
- Clean brass filters.
- Check Venturi generator inlet for obstructions.
- Ensure that the through hole for the vacuum pallet is a minimum of 1/4 inch in diameter and is chamfered.
- Check air lines for leak.
- Check workpiece for flatness.
- Ensure the exhaust air line is not blocked.